

**EPSON**



Google TV

**User's Guide**

# Home Projector

Lifestudio GRAND **EH-LS670B**

Lifestudio GRAND **EH-LS670W**

## **Notations Used in This Guide** **5**

---

### **Using the Manual to Search for Information** ..... 7

- Searching by Keyword ..... 7
- Jumping Directly from Bookmarks ..... 7
- Printing Only the Pages You Need ..... 7

### **Getting the Latest Version of the Documents** ..... 8

## **Introduction to Your Projector** **9**

---

### **Projector Parts and Functions** ..... 10

- Projector Parts - Front/Side ..... 10
- Projector Parts - Top/Side ..... 11
- Projector Parts - Rear ..... 12
- Projector Parts - Base ..... 13
- Projector Parts - Remote Control ..... 13

## **Setting Up the Projector** **16**

---

### **Projector Placement** ..... 17

- Projector Setup and Installation Options ..... 18
- Precautions on Installation ..... 19

### **Projector Connections** ..... 20

- Connecting to Video Sources ..... 20
- Connecting to External USB Devices ..... 20
- Connecting to External Audio Devices ..... 21
- Connecting to an eARC/ARC Compatible AV System ..... 22
- Connecting Headphones ..... 22

### **Installing Batteries in the Remote Control** ..... 24

- Remote Control Operation ..... 24

### **Setting Up the Projector OS** ..... 26

- Projector's Home Screen ..... 26

### **About Epson Projector Update** ..... 28

- Installing Epson Projector Update ..... 28

## **Using Basic Projector Features** **29**

---

### **Turning On the Projector** ..... 30

### **Turning Off the Projector (Suspended Mode)** ..... 31

- Turning Off the Projector (Deep Standby Mode) ..... 31

### **Projection Modes** ..... 32

- Changing the Projection Mode Using the Menus ..... 32

### **Focusing the Image Using the Focus Lever** ..... 33

### **Correcting Distortion in the Image** ..... 34

- When Projecting on a Wall ..... 34
- When Projecting on a Screen ..... 35

### **Adjusting Image Color** ..... 37

### **Adjusting the Size and Position of the Image** ..... 38

### **Selecting an Image Source** ..... 39

### **Image Aspect Ratio** ..... 40

- Changing the Image Aspect Ratio ..... 40
- Available Image Aspect Ratios ..... 40

### **Adjusting Image Quality (Color Mode)** ..... 41

- Changing the Color Mode ..... 41
- Available Color Modes ..... 41

### **Adjusting Image Quality in Detail** ..... 42

### **Turning On Automatic Luminance Adjustment** ..... 43

### **Adjusting the Light Source Brightness** ..... 44

### **Controlling the Volume with the Volume Buttons** ..... 45

### **Changing the Sound Mode** ..... 46

Available Sound Modes .....46

## **Adjusting Projector Features 47**

---

**Using the Projector as a Bluetooth® Speaker ..... 48**

**Shutting Off the Image Temporarily ..... 49**

**Using Google Cast™ .....50**

**HDMI CEC Features ..... 51**

Operating Connected Devices Using the HDMI CEC Features ..... 51

**Installing a Security Cable ..... 52**

**Updating Projector Firmware Using Epson Projector Update ..... 53**

**Initializing the Projector ..... 54**

## **Adjusting the Menu Settings 55**

---

**Using the Projector's Menus ..... 56**

**Projector Feature Settings - Channels & Inputs Menu .....57**

**Projector Feature Settings - Projector Menu .....58**

**Image Quality Settings - Display & Sound Menu ..... 59**

**Other Menus ..... 61**

Network & Internet Menu ..... 61

Accounts & Profiles Menu ..... 61

Privacy Menu ..... 61

Apps Menu ..... 61

System Menu ..... 61

Accessibility Menu ..... 61

Remotes & Accessories Menu ..... 62

Help & Feedback Menu ..... 62

## **Maintaining the Projector 63**

---

**Projector Maintenance ..... 64**

**Cleaning the Projection Window ..... 65**

**Cleaning the Motion Sensor ..... 66**

**Cleaning the Projector Case .....67**

**Air Filter and Air Intake Vent Maintenance ..... 68**

Cleaning the Air Filter .....68

Replacing the Air Filter .....69

Cleaning the Air Intake Vents ..... 70

**Adjusting the Color Convergence (Panel Alignment) .....71**

## **Solving Problems 73**

---

**Projection Problems ..... 74**

**Projector Indicator Status ..... 75**

**Solving Projector Power-On or Power-Off Problems .....77**

Solving Projector Power Problems .....77

Solving Projector Shutdown Problems ..... 77

**Solving Image Problems ..... 78**

Solving Missing Image Problems .....78

Adjusting an Image that is not Rectangular .....79

Adjusting a Fuzzy or Blurry Image ..... 79

Fixing Partial Image Problems .....79

Adjusting an Image that Contains Noise or Static ..... 80

Adjusting an Image with Incorrect Brightness or Colors ..... 80

**Solving Sound Problems ..... 81**

Solving Missing or Low Audio Problems ..... 81

Solving Bluetooth Speaker Mode Problems ..... 81

**Solving Remote Control Operation Problems ..... 83**



<b>Solving HDMI CEC Problems .....</b>	<b>84</b>
<b>Solving Wi-Fi Network Problems .....</b>	<b>85</b>
<b>Solving Projector's OS Problems .....</b>	<b>86</b>
<b>Appendix .....</b>	<b>87</b>
<hr/>	
<b>Optional Accessories and Replacement Parts .....</b>	<b>88</b>
Screens .....	88
Replacement Parts .....	88
<b>Screen Size and Projection Distance .....</b>	<b>89</b>
<b>Supported Monitor Display Resolutions .....</b>	<b>90</b>
<b>Projector Specifications .....</b>	<b>91</b>
Connector Specifications .....	91
Bluetooth Specifications .....	92
<b>External Dimensions .....</b>	<b>93</b>
<b>List of Safety Symbols and Instructions .....</b>	<b>94</b>
<b>Laser Safety Information .....</b>	<b>96</b>
Laser Warning Labels .....	96
<b>Glossary .....</b>	<b>99</b>
<b>Notices .....</b>	<b>100</b>
FCC Compliance Statement .....	100
Indication of the manufacturer and the importer in accordance with requirements of EU directive .....	101
Restriction of Use .....	101
Trademarks .....	101
Copyright Notice .....	101
Copyright Attribution .....	102

# Notations Used in This Guide







## Safety Symbols

The projector and its manuals use graphical symbols and labels to indicate content that tells you how to use the projector safely.

Read and carefully follow the instructions that are marked with these symbols and labels to avoid injury to persons or damage to property.

 <b>Warning</b>	This symbol indicates information that, if ignored, could possibly result in personal injury or even death.
 <b>Caution</b>	This symbol indicates information that, if ignored, could possibly result in personal injury or physical damage due to incorrect handling.

## General Information Notations

<b>Attention</b>	This label indicates procedures that may result in damage or injury if sufficient care is not taken.
	This label indicates additional information that may be useful to know.
 button	Indicates the buttons on the remote control or the control panel. Example:  button
<b>Menu/Setting name</b>	Indicates projector menu and setting names. Example: Select the <b>Projector</b> menu.  <b>Projector &gt; Keystone &gt; Zoom &amp; Shift</b>
	This label indicates links to the related pages.
	This label indicates the projector's current menu level.

## ▶▶ Related Links

- "Using the Manual to Search for Information" [p.7](#)

- "Getting the Latest Version of the Documents" [p.8](#)

The PDF manual allows you to search for information you are looking for by keyword, or jump directly to specific sections using the bookmarks. You can also print only the pages you need. This section explains how to use a PDF manual that has been opened in Adobe Reader X on your computer.

### ► Related Links

- "Searching by Keyword" [p.7](#)
- "Jumping Directly from Bookmarks" [p.7](#)
- "Printing Only the Pages You Need" [p.7](#)

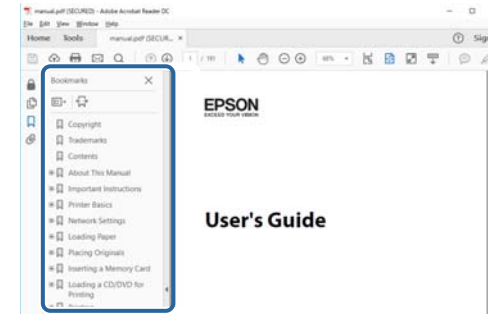

## Searching by Keyword

Click **Edit > Advanced Search**. Enter the keyword (text) for information you want to find in the search window, and then click **Search**. Hits are displayed as a list. Click one of the displayed hits to jump to that page.

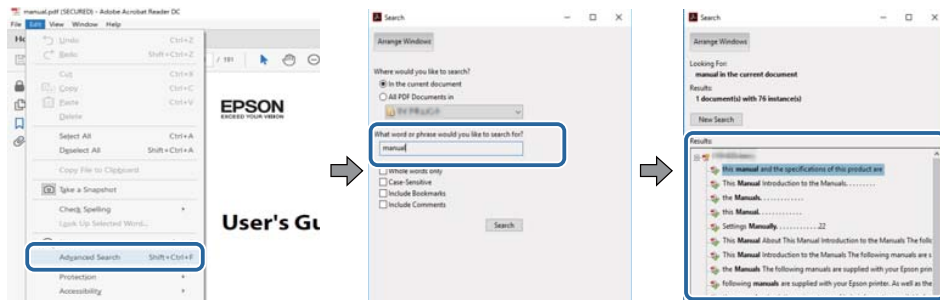

## Printing Only the Pages You Need

You can extract and print only the pages you need. Click **Print** in the **File** menu, and then specify the pages you want to print in **Pages in Pages to Print**.

- To specify a series of pages, enter a hyphen between the start page and the end page.  
Example: 20-25
- To specify pages that are not in series, divide the pages with commas.  
Example: 5, 10, 15

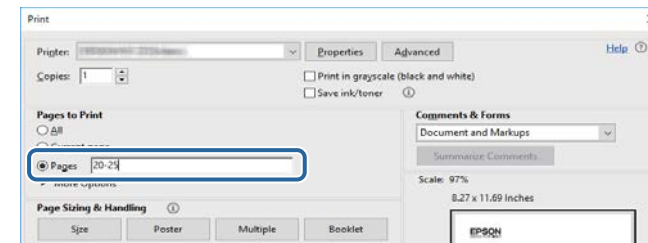

## Jumping Directly from Bookmarks

Click a title to jump to that page. Click + or > to view the lower level titles in that section. To return to the previous page, perform the following operation on your keyboard.

- Windows: Hold down **Alt**, and then press **←**.
- Mac OS: Hold down the command key, and then press **←**.

You can get the latest version of the manuals and specifications on the Epson website.

Visit [epson.sn](http://epson.sn), and enter your model name.

# Introduction to Your Projector

See these sections to learn more about your projector.

## ▶ **Related Links**

- "Projector Parts and Functions" [p.10](#)

The following sections explain the projector parts and their functions.

This product may use sensors, such as a camera and a microphone. These sensors may collect information related to privacy (such as locations, sounds, videos, or images).

► **Related Links**

- "Projector Parts - Front/Side" [p.10](#)
- "Projector Parts - Top/Side" [p.11](#)
- "Projector Parts - Rear" [p.12](#)
- "Projector Parts - Base" [p.13](#)
- "Projector Parts - Remote Control" [p.13](#)

## Projector Parts - Front/Side

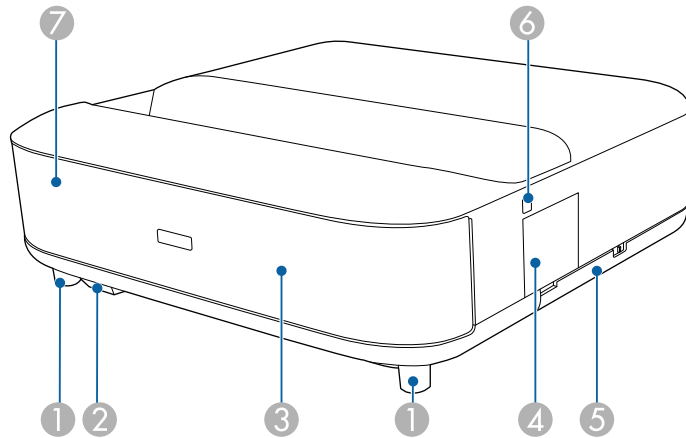

Name	Function
① Front adjustable feet	When set up on a surface such as a desk, turn to extend or retract the feet to adjust the horizontal tilt.
② Remote receiver	Receives signals from the remote control.

Name	Function
③ Speaker	Outputs audio.  <div style="border: 1px solid black; background-color: #ffffcc; padding: 5px;"> <p><b>⚠ Caution</b> Do not hold or hit this part as doing so may cause it to deform.</p> </div>
④ Focus lever cover	Open to access the focus lever.
⑤ Air filter cover	Open to access the air filter.
⑥ Power button	Turns the projector on or off.
⑦ Status indicator	Indicates the projector's status.

► **Related Links**

- "Remote Control Operation" [p.24](#)
- "Turning On the Projector" [p.30](#)
- "Focusing the Image Using the Focus Lever" [p.33](#)
- "Air Filter and Air Intake Vent Maintenance" [p.68](#)
- "Projector Indicator Status" [p.75](#)

## Projector Parts - Top/Side

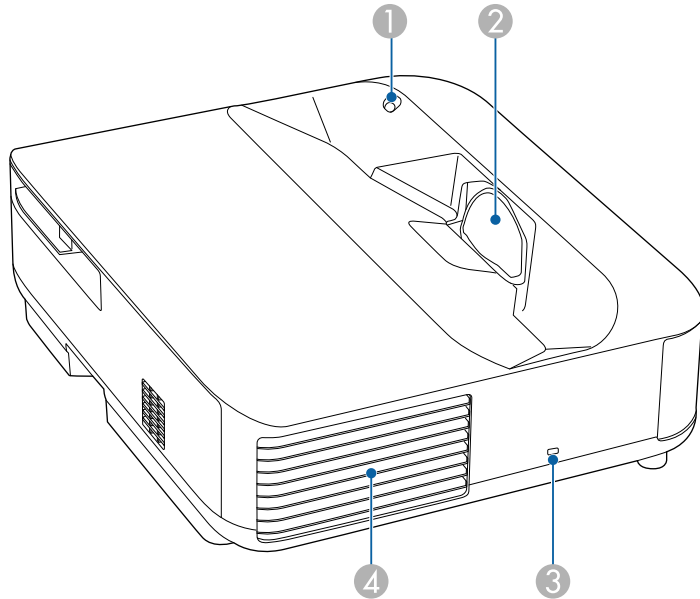

Name	Function
1 Motion sensor	<p>Detects movement near the projection window and reduces the brightness of the light source for safety.</p> <div style="border: 1px solid black; padding: 5px; margin-top: 10px;">  <ul style="list-style-type: none"> <li>The detection range may vary depending on the temperature of the surroundings.</li> <li>Movement may not be detected through transparent material such as glass.</li> </ul> </div>

Name	Function
2 Projection window	<p>Images are projected from the lens inside the projector.</p> <div style="border: 1px solid black; padding: 10px; margin-top: 10px;"> <p><b>Warning</b></p> <ul style="list-style-type: none"> <li>Do not look into the projection window while projecting.</li> <li>Do not place any objects or put your hand near the projection window. It could cause burns, fire, or the object to warp because this area reaches a high temperature due to the concentrated projection light.</li> </ul> </div>
3 Security slot	<p>The security slot is compatible with the Microsaver Security System manufactured by Kensington.</p>
4 Air exhaust vent	<p>Exhaust vent for air used to cool the projector internally.</p> <div style="border: 1px solid black; padding: 10px; margin-top: 10px;"> <p><b>Caution</b></p> <p>While projecting, do not put your face or hands near the air exhaust vent, and do not place objects that may become warped or damaged by heat near the vent. Hot air from the air exhaust vent could cause burns, warping, or accidents to occur.</p> </div>

►► **Related Links**

- "Cleaning the Motion Sensor" [p.66](#)
- "Cleaning the Projection Window" [p.65](#)
- "Installing a Security Cable" [p.52](#)

## Projector Parts - Rear

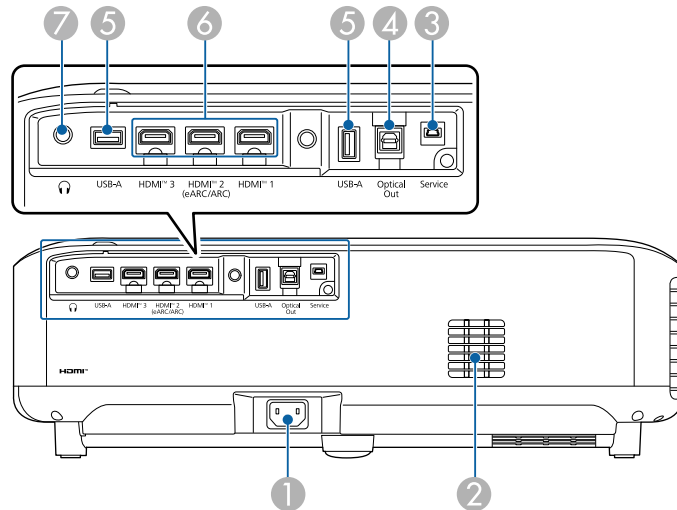

Name	Function
1 Power inlet	Connects the power cord to the projector.
2 Air intake vent	Takes in air to cool the projector internally.
3 Service port	This port is used by service technicians and should not normally be used.
4 Optical Out port	Outputs audio from the current input source to an external audio device by connecting an optical digital audio cable.

Name	Function
5 USB-A port	<p>Connects a commercially available USB device such as a webcam, external HDD, or keyboard.</p> <p>Connects a commercially available RJ45 adapter to enable wired LAN connections.</p> <div style="border: 1px solid black; padding: 5px; margin-top: 10px;"> <p> This port is not guaranteed to operate for all devices that support USB.</p> </div>
6 HDMI1 port HDMI2 (eARC/ARC) port HDMI3 port	<p>Inputs video signals from HDMI compatible video equipment and computers. This projector is compatible with HDCP 2.3.</p> <p>The HDMI2 port is compatible with HDMI eARC and ARC.</p> <p>Each port supports the following refresh rate:</p> <ul style="list-style-type: none"> <li>• HDMI1/HDMI2 ports: 4K 120 Hz</li> <li>• HDMI3 port: 4K 60 Hz</li> </ul>
7 Audio Out port	Outputs audio from the current input source to headphones.

### ► Related Links

- "Connecting to Video Sources" [p.20](#)
- "Connecting to External USB Devices" [p.20](#)
- "Connecting to External Audio Devices" [p.21](#)
- "Connecting to an eARC/ARC Compatible AV System" [p.22](#)
- "Connecting Headphones" [p.22](#)

## Projector Parts - Base

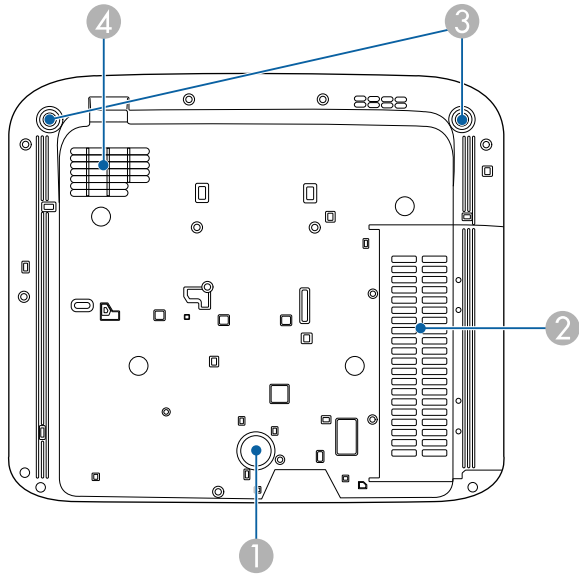







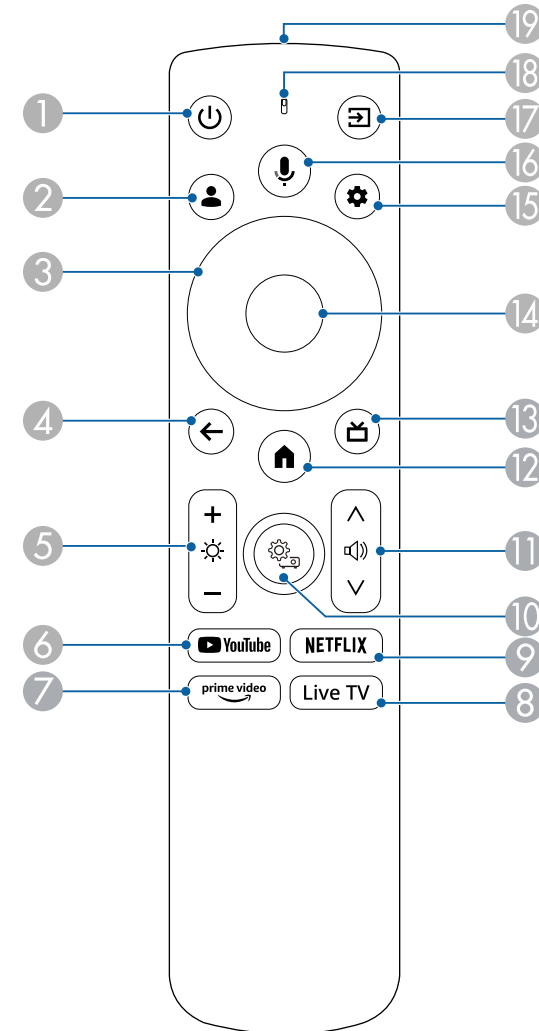

Name	Function
1 Rear foot	Stabilizes the projector on a surface such as a desk.
2 Air intake vent (air filter)	Takes in air to cool the projector internally.
3 Front adjustable feet	When set up on a surface such as a desk, turn to extend or retract the feet to adjust the horizontal tilt.
4 Air intake vent	Takes in air to cool the projector internally.



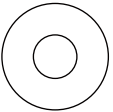

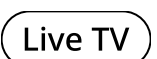

### ►► Related Links



- "Cleaning the Air Intake Vents " [p.70](#)

## Projector Parts - Remote Control



Name	Function
① Power button 	Turns the projector on or off.
② User Profile button 	Displays the user profile.
③ Arrow buttons 	Selects items on the home screen to play online content. Selects menu items while displaying the projector's menu.
④ Esc button 	Stops the current function. Moves back to the previous menu level while displaying the projector's menu.
⑤ Brightness buttons 	Lightens or darkens the projected image.
⑥ YouTube button 	Starts the YouTube application.
⑦ Prime Video button 	Starts the Amazon Prime Video application.
⑧ Live TV button 	Starts the Live TV application. <div style="border: 1px solid black; padding: 5px; margin-top: 10px;">  <p>Live TV is not available in certain languages and countries. Availability of services varies by country and language.</p> </div>

Name	Function
⑨ Netflix button 	Starts the Netflix application.
⑩ Projector Settings button 	Displays the <b>Projector</b> menu.
⑪ Volume up/down buttons 	Adjusts the volume for the speaker and headphones.
⑫ Home button 	Displays the home screen.
⑬ HDMI button 	Switches to the last HDMI source you displayed.
⑭ [Enter] button 	Enters the current selection and moves to the next level while displaying the projector's menu.
⑮ Settings button 	Opens the dashboard.

Name		Function
16	Google Assistant button 	Press the Google Assistant button on the remote, and say, "Hey Google" to get started.  <div style="border: 1px solid #ccc; background-color: #fff9c4; padding: 5px; width: fit-content;">  <p>Google Assistant is not available in certain languages and countries. Availability of services varies by country and language.</p> </div>
17	Source Search button 	Displays a list of available input sources.
18	Indicator/Microphone	Turns on when outputting signals from the remote control.  Detects your voice when you press the Google Assistant button.
19	Remote control light emitting area	Outputs remote control signals.

### ►► Related Links

- "Remote Control Operation" [p.24](#)
- "Installing Batteries in the Remote Control" [p.24](#)
- "Turning On the Projector" [p.30](#)
- "Turning Off the Projector (Suspended Mode)" [p.31](#)
- "Projector's Home Screen" [p.26](#)
- "Adjusting the Light Source Brightness" [p.44](#)
- "Controlling the Volume with the Volume Buttons" [p.45](#)
- "Projector's Home Screen" [p.26](#)
- "Selecting an Image Source" [p.39](#)
- "Using the Projector's Menus" [p.56](#)

# Setting Up the Projector

Follow the instructions in these sections to set up your projector.

## ► Related Links

- "Projector Placement" [p.17](#)
- "Projector Connections" [p.20](#)
- "Installing Batteries in the Remote Control" [p.24](#)
- "Setting Up the Projector OS" [p.26](#)
- "About Epson Projector Update" [p.28](#)

Install the projector on a table in your living room or on a low shelf to project images.

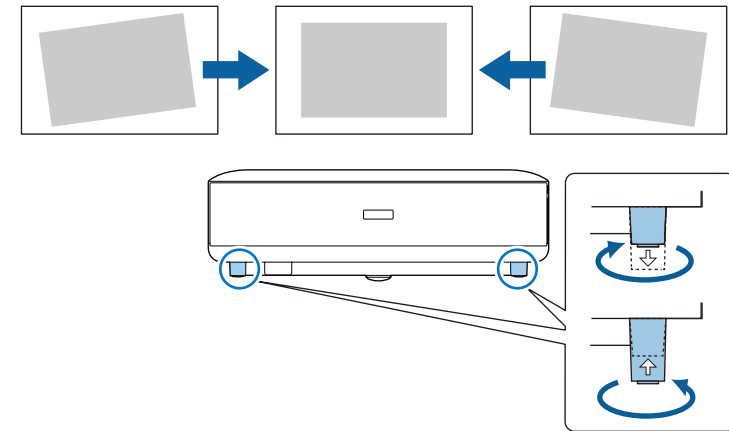
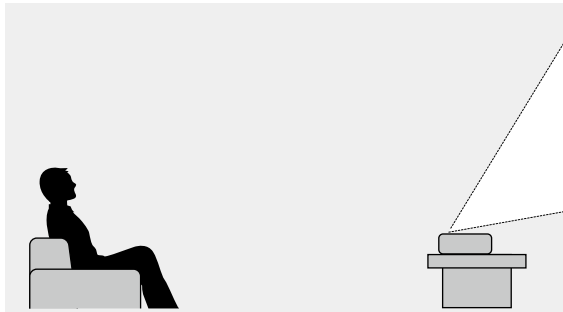

Note the following points when selecting a projector location:

- Place the projector on a sturdy and level surface.

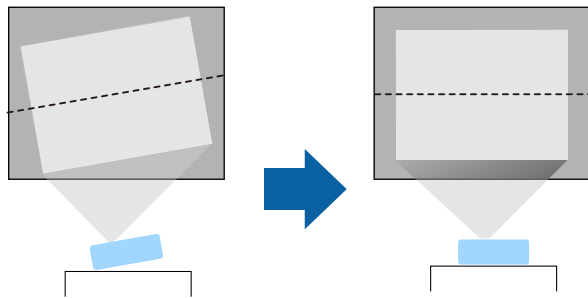

- If the image is tilted, rotate the front feet to adjust their height.

- Leave plenty of space around and under the projector for ventilation, and do not place it on top of or next to anything that could block the vents.
- Place the projector so it squarely faces the screen, not at an angle.

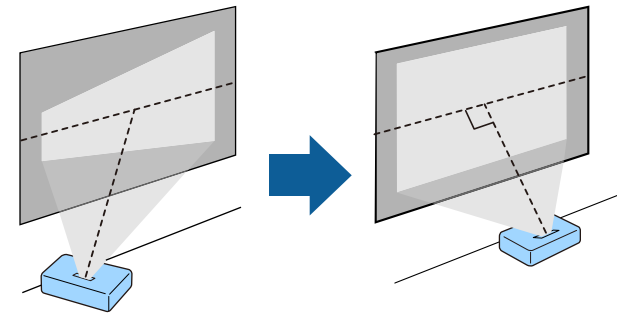

If you cannot install the projector squarely facing the screen, correct any resulting keystone distortion using the projector controls. For the best quality images, we recommend adjusting the installation position of the projector to achieve the correct image size and shape.

## ⚠ Warning

Do not install the projector in a location subject to high levels of dust or humidity, or in a location subject to smoke or steam. Otherwise, it could cause a fire or electric shock to occur.

## ⚠ Warning

- Do not cover the projector's air intake or air exhaust vents. If the vents are covered, the internal temperature could rise and cause a fire.
- Do not use or store the projector in locations where it will be subject to dust or dirt. Otherwise, the quality of the projected image may decline, or the air filter may become clogged, resulting in a malfunction or fire.
- Do not install the projector on an unstable surface or in a location beyond the weight specifications of the projector. Otherwise, it could fall or topple causing an accident and injury.
- Do not install in locations where salt damage could occur, or in locations subject to corrosive gas such as sulphuric gas from hot springs. Otherwise, corrosion could cause the projector to fall. It could also cause the projector to malfunction.

## Attention

- Make sure you do not operate the projector in the following positions.
  - Do not operate the projector on its side.
  - Do not project images straight up or straight down.
  - Do not tilt the projector right or left.
- If you are using the projector at altitudes above 1,500 m, set the **High Altitude Mode** setting to **On** in the projector's menu to ensure the projector's internal temperature is regulated properly.

🖱 **Projector > Advanced Settings > High Altitude Mode**

## ▶ Related Links

- "Projector Setup and Installation Options" [p.18](#)
- "Precautions on Installation" [p.19](#)

## Projector Setup and Installation Options

You can set up or install your projector in the following ways:

Front/Rear

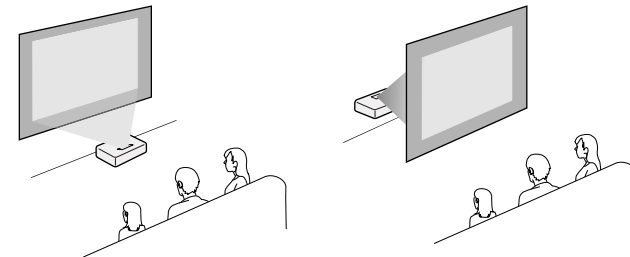

The default **Projection** setting is **Front**.

## ▶ Related Links

- "Changing the Projection Mode Using the Menu" [p.32](#)

## Precautions on Installation

### Installation space

#### Attention

Be sure to leave the following amount of space around the projector so as not to block the air exhaust and intake vents.

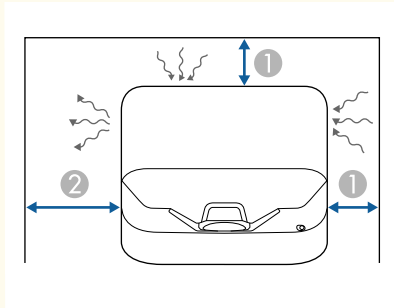

① 10 cm

② 30 cm

See these sections to connect the projector to a variety of projection sources.

## Attention

Check the shape and orientation of the connectors on any cable you plan to connect. Do not force a connector into a port if it does not fit. The device or your projector could be damaged or could malfunction.

### ► Related Links

- "Connecting to Video Sources" [p.20](#)
- "Connecting to External USB Devices" [p.20](#)
- "Connecting to External Audio Devices" [p.21](#)
- "Connecting to an eARC/ARC Compatible AV System" [p.22](#)
- "Connecting Headphones" [p.22](#)

## Connecting to Video Sources

If your video source has an HDMI port, you can connect it to the projector using an HDMI cable and send the image source's audio with the projected image.

## Attention

Do not turn on the video source before connecting it to the projector. Doing so could damage the projector.



- If the port on the device you connect has an unusual shape, use the cable supplied with the device or an optional cable to connect to the projector.
- Some video devices are capable of outputting different types of signals. See your video device manual to confirm what type of signals can be output.
- When sending 18 Gbps images such as 4K 60 Hz 4:4:4, use an HDMI cable (premium-high speed). If you use an incompatible cable, images may not be displayed correctly.
- When connecting a gaming console, we recommend connecting it to a port that supports the refresh rate of 120 Hz (HDMI1 or HDMI2). See the *Supplemental A/V Support Specification* for detailed information on compatible refresh rates and resolutions for each compatible video display format.

- 1** Connect the HDMI cable to your video source's HDMI output port.
- 2** Connect the other end to the projector's HDMI port.

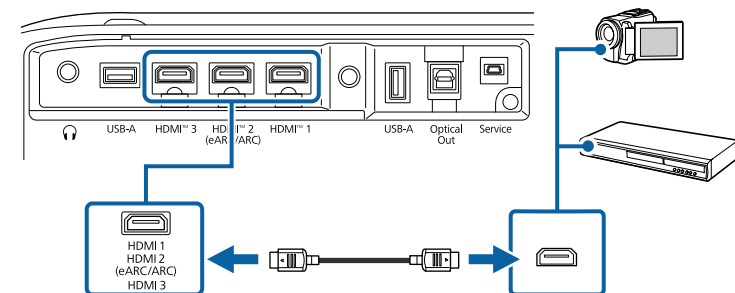

## Connecting to External USB Devices

By connecting any of these devices to your projector, you can project images and other content or play audio without using a video device.

- Microphone

- USB flash drive
- Digital camera
- USB hard drive



- The USB-A port is not guaranteed to operate all devices that support USB.
- You may need an app to project content from your USB device.
- USB hard drives must meet these requirements:
  - USB Mass Storage Class-compliant (not all USB Mass Storage Class devices are supported)
  - Formatted in FAT16/32
  - Self-powered by their own AC power supplies (bus-powered hard drives are not recommended)
  - Avoid using hard drives with multiple partitions

### Attention

- Use the USB cable supplied with or specified for use with the device.
- If the USB cable is too long, the device may not operate correctly. We recommend using a USB cable that is three meters or less.
- If you use a USB hub, the device may not operate correctly. We recommend checking the operation in advance.

**3** Connect the other end to your device, if necessary.

## Connecting to External Audio Devices

If your amplifier or speaker has an optical digital audio input port, you can connect it to the projector using an optical digital audio cable and project audio from the image source.

**1** Connect the optical digital audio cable to your audio device's optical digital audio input port.

**2** Connect the other end to the projector's Optical Out port.

**1** If your USB device came with a power adapter, plug the device into an electrical outlet.

**2** Connect the USB device to the projector's USB-A port as shown.

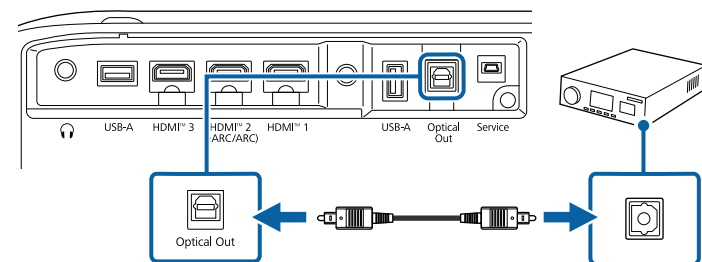
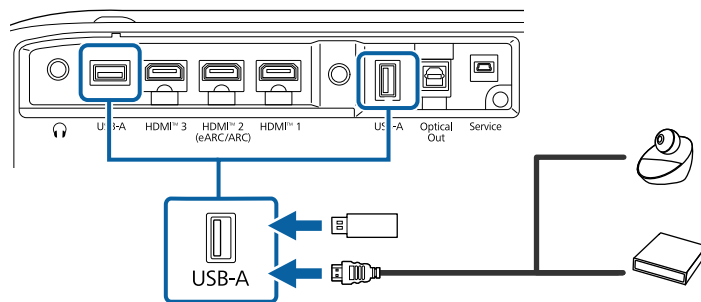



If you set **Audio Output Device** to **SPDIF** in the projector's menu, audio is only output from the external audio device and is not output from the projector's speakers.

☛ **Display & Sound > Audio Output > Audio Output Device**

## ▶ Related Links

- "Image Quality Settings - Display & Sound Menu" [p.59](#)

## Connecting to an eARC/ARC Compatible AV System

If your AV system or speakers, such as a sound bar, has an HDMI port, you can connect them to the projector using an HDMI cable (with Ethernet) to output audio to these devices.

- 1** Connect the HDMI cable to your AV system's HDMI output port (eARC or ARC compatible).

- 2** Connect the other end to the projector's HDMI2 (eARC/ARC) port.

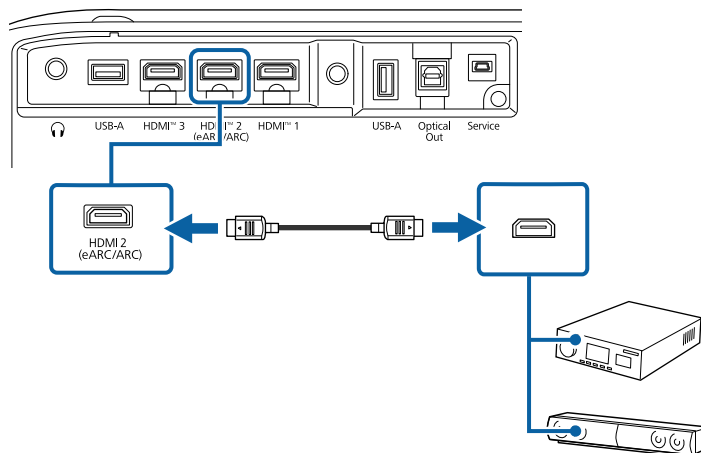

- 3** Make any necessary settings on the connected AV system. See your device's documentation for more information.



- To output audio from the projector's HDMI2 (eARC/ARC) port when using an ARC connection, set **Global CEC control** to **On** in the projector's menu.

☛ **Channels & Inputs > Inputs > Global CEC control**

- If audio is not output properly, try changing **Auto** to **PCM** as the **Digital Output** setting in the projector's menu.

☛ **Display & Sound > Audio Output > Digital Output**

- See the *Supplemental A/V Support Specification* for eARC/ARC audio supported formats.

## ▶ Related Links

- "Projector Feature Settings - Channels & Inputs Menu" [p.57](#)
- "Image Quality Settings - Display & Sound Menu" [p.59](#)

## Connecting Headphones

You can connect headphones to the projector's Audio Out port. You can control the volume using the projector's remote control.

### Attention

The projector's Audio Out port only supports 3-pin headphones. If you use any other headphones, audio may not be output normally.

- 1** Connect the stereo headphone's mini-jack cable to the projector's Audio Out port.

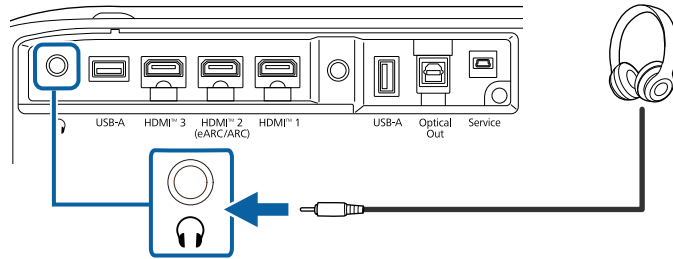

## **⚠ Caution**

Do not start a playback at a high volume setting. Sudden loud noises may cause hearing loss.

Always lower the volume before powering off, so that you can power on and then gradually increase the volume.

The remote control uses the two AAA batteries that came with the projector.

## Attention

Make sure you read the *Safety Instructions* before handling the batteries.

- 1 Remove the battery cover as shown.

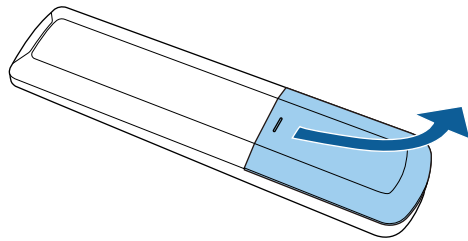

- 2 Remove the old batteries, if necessary.



Dispose of used batteries according to local regulations.

- 3 Insert the batteries with the + and - ends facing as shown.

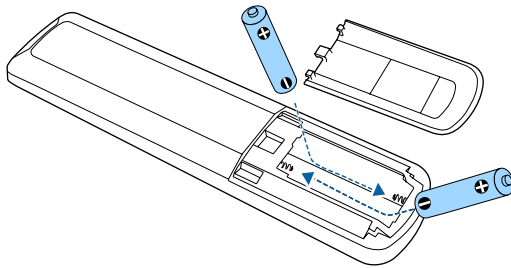

## Warning

Check the positions of the (+) and (-) marks inside the battery holder to ensure the batteries are inserted the correct way. If the batteries are not used correctly, they could explode or leak causing a fire, injury, or damage to the product.

- 4 Replace the battery cover and press it down until it clicks into place.

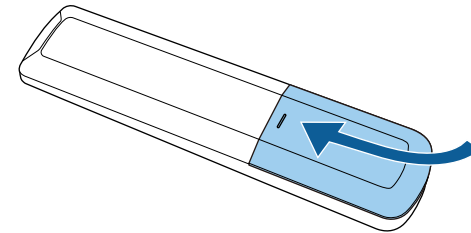

## Related Links

- ["Remote Control Operation" p.24](#)

## Remote Control Operation

The remote control lets you control the projector from almost anywhere in the room.

It is recommended that you aim the remote control at the projector's receivers within the distance and angles listed here.

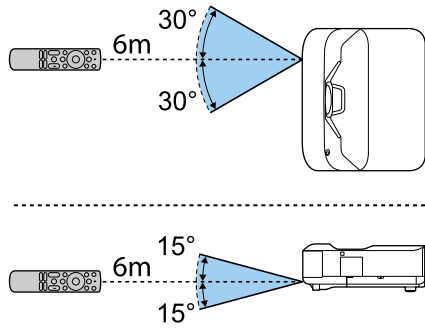



The projector may not respond to commands if you use the remote control in conditions with bright fluorescent lights or in direct sunlight. If you are not going to use the remote control for a long time, remove the batteries.

When you turn on the projector for the first time, you need to set up the projector's OS using the initial setup wizard.



You can change each of the settings even after completing the initial setup.

**1** Turn on the projector.

**2** When the pairing screen is displayed, hold down the  button and  button on the remote control at the same time to pair the remote control and the projector.

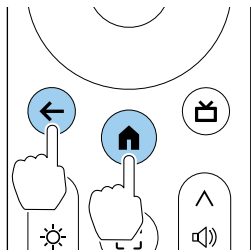

- When pairing, place the remote control within one meter of the projector.
- When pairing starts, the indicator on the remote control flashes. When pairing is complete, the indicator turns off.
- You cannot pair multiple remote controls with the projector at the same time. Pairing a new remote control will unpair the existing one. Make sure the intended remote control is paired.

**3** When the language selection screen is displayed, select the language you want to use, and then follow the on-screen instructions to select your country or region.

**4** When the setting screen is displayed, follow the on-screen instructions to make the initial settings for the projector's OS.



- We recommend logging in with your Google Account to make more detailed settings.
- For instructions on how to create a Google Account, contact Google or see the following website.

[Google Account Help](#)

**5** When the Wi-Fi setting screen is displayed, select the wireless network you want to use, and then follow the on-screen instructions to make necessary settings.

- An Internet connection is required to view online content. Make sure you can use the Wi-Fi service.
- The customer is responsible for any communication charges incurred when downloading the app or watching online content.

**6** Follow the on-screen instructions to make other necessary settings.

**7** When you agree to the Epson license terms, the initial setup wizard closes.

When you have finished the initial setup, the home screen is displayed.

## ► Related Links

- "Projector's Home Screen" [p.26](#)

## Projector's Home Screen

When you turn on the projector or press the  button on the remote control, the home screen is displayed.

You can easily access recommended online content and applications from the home screen.

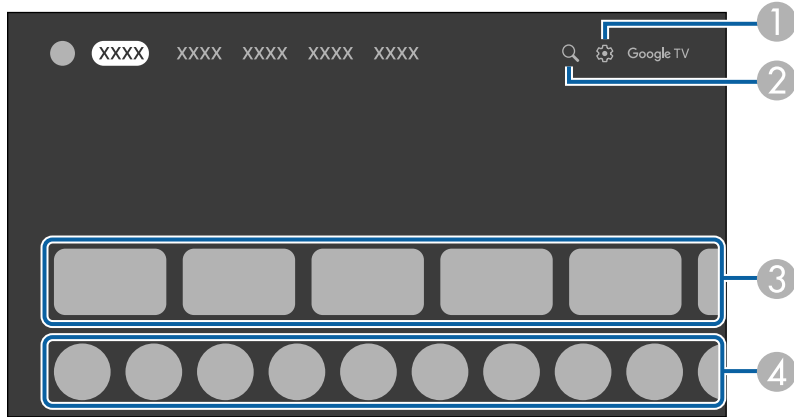

	Description
①	Displays the dashboard menu.
②	Searches for online content.
③	Displays the online content recommended by the applications.
④	Displays the applications downloaded on the projector.



The content of the home screen may change depending on the version of the projector's OS.

The Epson Projector Update app allows you to check the projector firmware and update it to the latest version. This is necessary to keep the projector up to date. Install the app, launch the app, and check for the latest firmware.



The Epson Projector Update app is automatically installed by the projector's initial setting wizard. To install it automatically, make sure you log in with your Google Account, make the necessary Wi-Fi settings, and connect the projector to the Internet.

### ▶ Related Links

- "Installing Epson Projector Update" [p.28](#)

## Installing Epson Projector Update

Follow the steps below to manually install the Epson Projector Update app.

- 1** Select the **Apps** icon at the top of the home screen and select the search field.

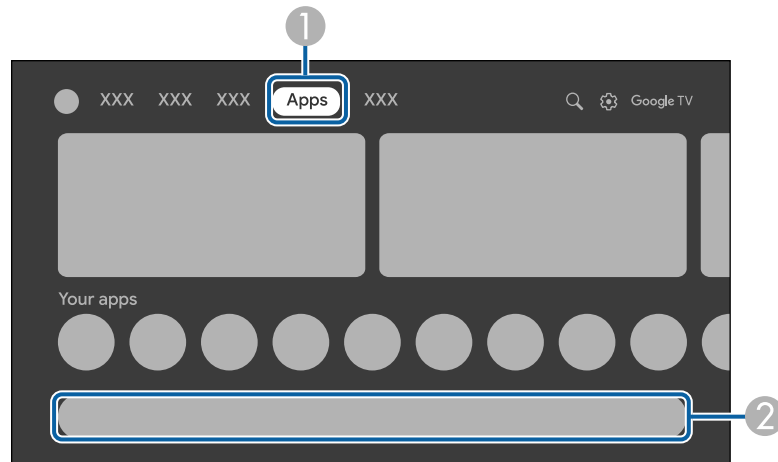

- 2** Search for "Epson Projector Update" to install it on the projector.

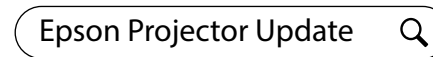

- 3** Start the Epson Projector Update app and confirm the latest projector firmware is installed on the projector.

### ▶ Related Links

- "Updating Projector Firmware Using Epson Projector Update" [p.53](#)

# Using Basic Projector Features

Follow the instructions in these sections to use your projector's basic features.

## ► Related Links

- ["Turning On the Projector" p.30](#)
- ["Turning Off the Projector \(Suspended Mode\)" p.31](#)
- ["Projection Modes" p.32](#)
- ["Focusing the Image Using the Focus Lever" p.33](#)
- ["Correcting Distortion in the Image" p.34](#)
- ["Adjusting Image Color" p.37](#)
- ["Adjusting the Size and Position of the Image" p.38](#)
- ["Selecting an Image Source" p.39](#)
- ["Image Aspect Ratio" p.40](#)
- ["Adjusting Image Quality \(Color Mode\)" p.41](#)
- ["Adjusting Image Quality in Detail" p.42](#)
- ["Turning On Automatic Luminance Adjustment" p.43](#)
- ["Adjusting the Light Source Brightness" p.44](#)
- ["Controlling the Volume with the Volume Buttons" p.45](#)
- ["Changing the Sound Mode" p.46](#)

When you connect the video equipment to the projector, turn on the video equipment you want to use after you turn on the projector.

- 1 Connect the power cord to the projector's power inlet and plug it into an electrical outlet.

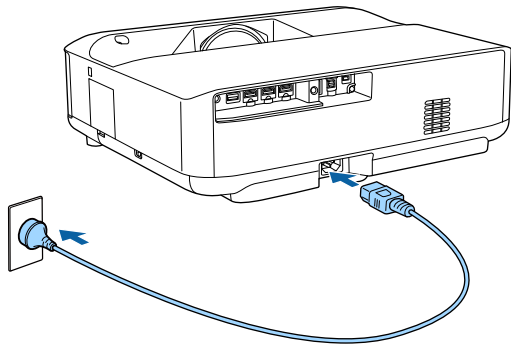

The projector enters standby mode. This indicates that the projector is receiving power, but is not yet turned on.

- 2 Press the power button on the projector or remote control to turn on the projector.

The status indicator turns white.

The first time you turn on the projector, the remote control pairing screen and initial setup screen are displayed. Follow the on-screen instructions to complete the settings.

## Warning

- Never look into the projector lens when the light source is on. This can damage your eyes and is especially dangerous for children.
- When turning on the projector at a distance using the remote control, make sure there is no one looking into the lens.
- During projection, do not block the light from the projector with a book or other objects. If the light from the projector is blocked, the area on which the light shines becomes hot which could cause it to melt, burn, or start a fire. Also, the lens may get hot due to the reflected light which could cause the projector to malfunction. To stop projection, turn off the projector.



When using at an altitude of 1,500 m or more, set **High Altitude Mode** to On.

 **Projector > Advanced Settings > High Altitude Mode**

## ▶▶ Related Links

- "Setting Up the Projector OS" [p.26](#)
- "Projector Feature Settings - Projector Menu" [p.58](#)

Turn off the projector after use.



Turn off this product when it is not in use to prolong the life of the projector. Light source life varies depending on the environmental conditions and usage. Brightness decreases over time.

- 1** Press the power button on the projector or remote control.  
The light source turns off, and the status indicator turns off. The projector enters suspended mode.
- 2** To transport or store the projector, make sure the status indicator on the projector is off, and then unplug the power cord.

▶ **Related Links**

- "Turning Off the Projector (Deep Standby Mode)" [p.31](#)

---

## Turning Off the Projector (Deep Standby Mode)

To reduce power consumption when the projector is not in use, turn off the projector completely using the remote control.



- In deep standby mode, the projector consumes less power than in suspended mode.
- It takes longer for the projector to start up the next time you turn it on than when it is in suspended mode.

- 1** Hold down the power button on the remote control.
- 2** Select OK on the shutdown confirmation screen.  
The light source turns off, and the status indicator turns off. The projector enters deep standby mode, reducing power consumption.

- 3** To transport or store the projector, make sure the status indicator on the projector is off, and then unplug the power cord.

Depending on how you positioned the projector, you may need to change the projection mode so your images project correctly.

- **Front** lets you project from in front of the screen.
- **Rear** flips the image horizontally to project from behind a translucent screen.



## ► Related Links

- "Changing the Projection Mode Using the Menus" [p.32](#)
- "Projector Setup and Installation Options" [p.18](#)

---

## Changing the Projection Mode Using the Menus

You can change the projection mode to flip the image from left-to-right using the projector menus.

- 1** Turn on the projector and display an image.
- 2** Press the  button on the remote control to open the **Projector** menu.
- 3** Select the menus in the following order:  
☛ **Advanced Settings > Projection**
- 4** Select a projection mode and press [Enter].
- 5** Press  to exit the menus.

You can correct the focus using the focus lever.

- 1** Turn on the projector and display an image.
- 2** Open the focus lever cover.

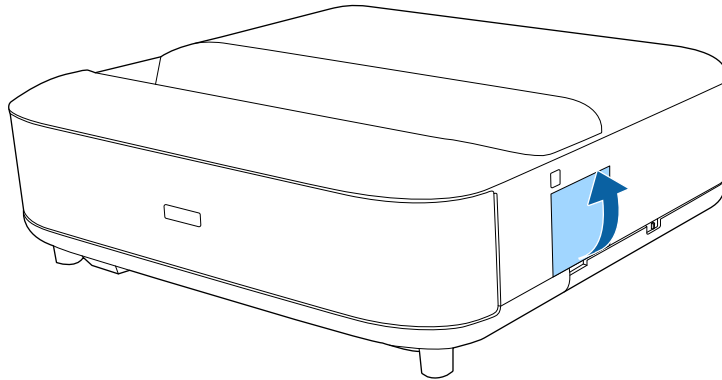

- 3** Move the focus lever to adjust the focus.

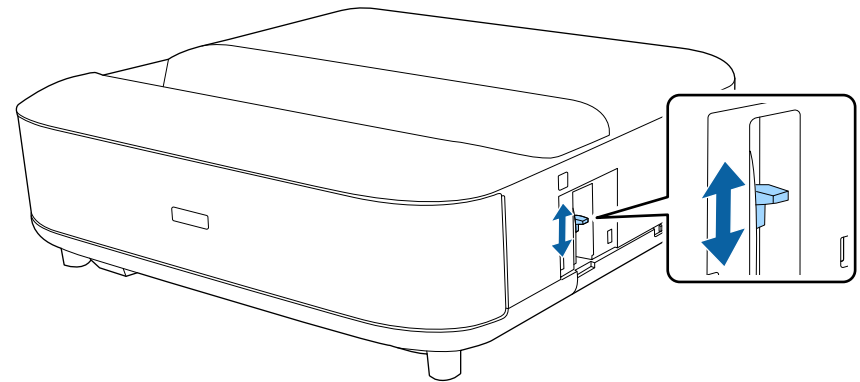
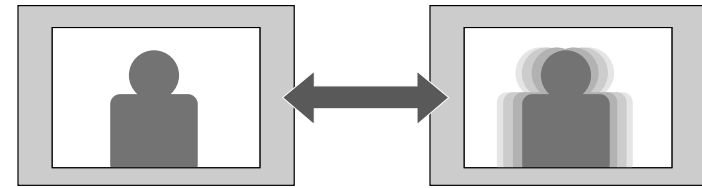

- 4** Close the focus lever cover.

When the projected image is curved or not rectangular, you can correct distortion in the projected image by following the on-screen instructions.

After correction, your image is slightly smaller.

- 1** Turn on the projector and display an image.
- 2** Press the  button on the remote control to open the **Projector** menu.
- 3** Select **Keystone**.
- 4** Select **Remote control**.

The following screen is displayed.

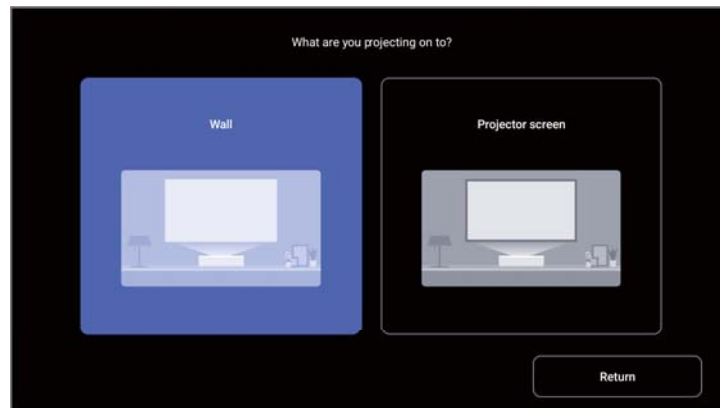

To correct distortion more easily, you can use the Epson Setting Assistant app on a smartphone or tablet that has a camera function. Select **App** and scan the QR code displayed on the projected screen to install the app. The customer is responsible for any communication charges incurred when downloading the app.

- 5** Select **Wall** or **Projector screen** according to the projection surface you are using.

- 6** Follow the on-screen instructions to correct distortion in the image.

- 7** Press  to exit the menu.



For details on the options for correcting distortion, see the following sections.

## ▶▶ Related Links

- "When Projecting on a Wall" [p.34](#)
- "When Projecting on a Screen" [p.35](#)

## When Projecting on a Wall

When you are projecting images on a wall, select **Wall** and follow the steps below.



When selecting the correction method, if the message **Reset all distortion corrections for the projected image?** is displayed, select **Yes**.

- 1 Select the shape of the projected image from the screen.

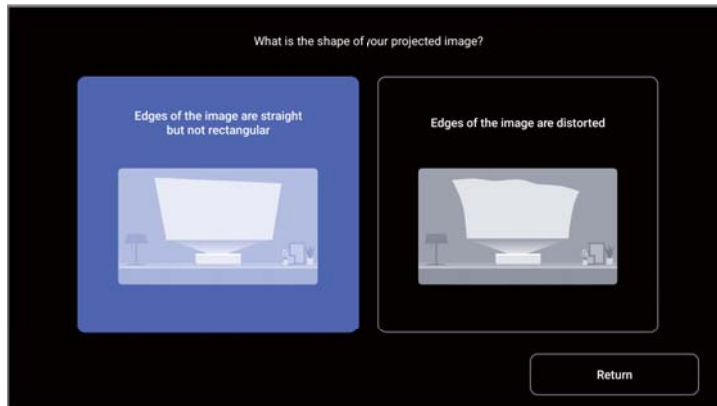

- **Edges of the image are straight but not rectangular:**  
The four-point correction screen is displayed. Select the points you want to correct and correct the distortion.
- **Edges of the image are distorted:**  
Go to step 2 to select how the projected image is distorted.

- 2 Select which part of the projected image is distorted on the screen.

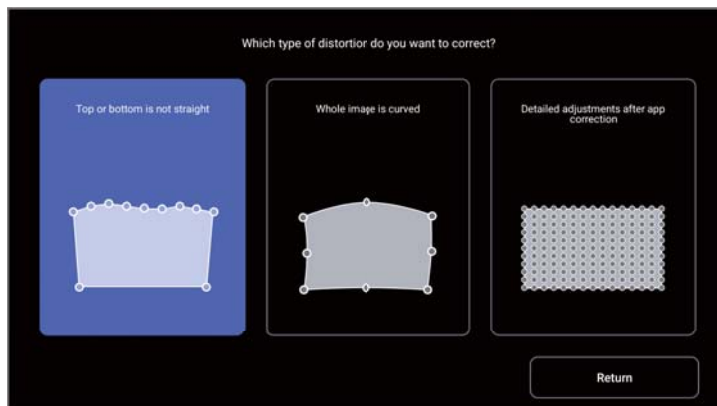

- **Top or bottom is not straight:**  
The eleven-point correction screen (top line with nine points, bottom line with two points) is displayed. Select the points you want to correct and correct the distortion.
- **Whole image is curved:**  
The eight-point correction screen is displayed. Select the points you want to correct and correct the distortion.
- **Detailed adjustments after app correction:**  
The point correction screen (33 × 33 points vertically and horizontally) is displayed. Select the points you want to correct and correct the distortion.

- 3 When you finish correcting the distortion, select **Finish**.

---

## When Projecting on a Screen

When you are projecting images on the projector screen, select **Projector screen** and follow the steps below.



When selecting the correction method, if the message **Reset all distortion corrections for the projected image?** is displayed, select **Yes**.

- 1 Move the projector following the on-screen instructions.

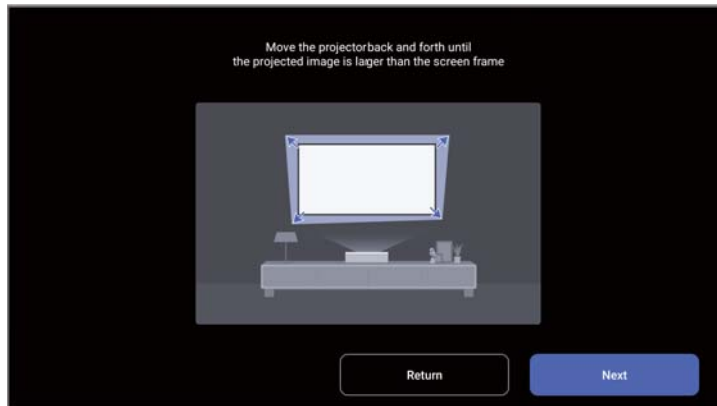

- 2 Select **Next**.  
The four-point correction screen is displayed.
- 3 Select the points you want to correct and correct the distortion.
- 4 If necessary, correct the distortion using the eight-point correction screen that is displayed when you select **Corner Adjustment** on the screen.
- 5 When you finish correcting the distortion, select **Finish**.

You can use the preset color correction to adjust the color of the projected image so that it matches the color of the projection surface (wall or projector screen).



You can make further detailed color adjustments using the projector's **Display & Sound** menu.

- 1 Turn on the projector and display an image.
- 2 Press the  button on the remote control to open the **Projector** menu.
- 3 Select **Keystone**.  
The following screen is displayed.

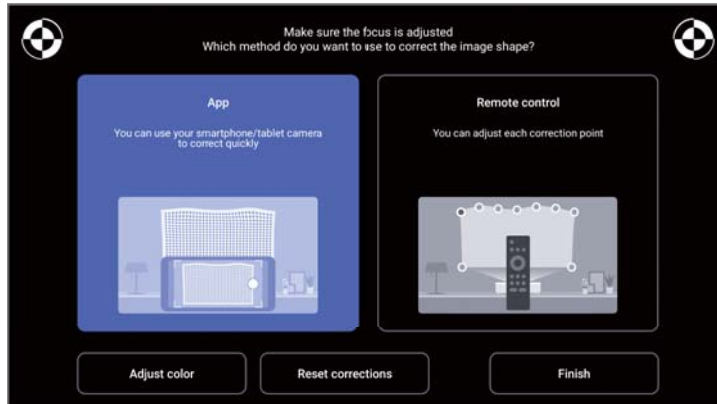

- 4 Select **Adjust color**.

- 5 Select the color that is closest to the color of the projection surface and select **OK**.

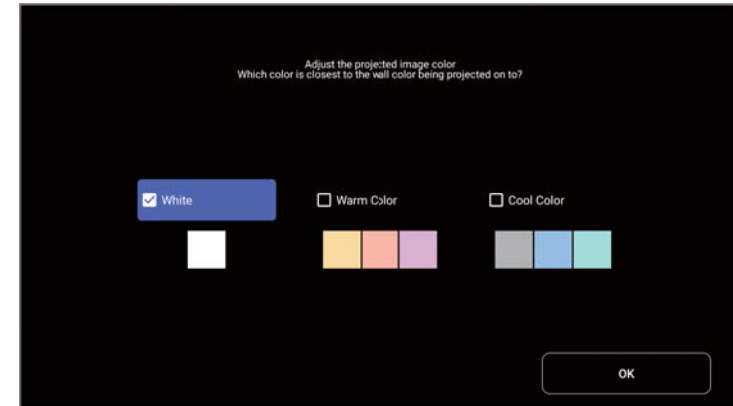

- 6 Press  to exit the menus.

## ► Related Links

- "Image Quality Settings - Display & Sound Menu" [p.59](#)

You can use the **Zoom & Shift** feature to adjust the size and position of the projected image.

- 1** Turn on the projector and display an image.
- 2** Press the  button on the remote control to open the **Projector** menu.
- 3** Select **Zoom & Shift**.  
The zoom adjustment screen is displayed.



- 4** Use the left and right arrow buttons to adjust the image size.
- 5** Press the [Enter] button.  
The screen switches to **Shift mode** and the shift adjustment screen is displayed.

- 6** Use the arrow buttons to adjust the image position.
- 7** Press  to exit the menus.

#### ▶▶ Related Links

- "Projector Feature Settings - Projector Menu" [p.58](#)

When multiple image sources are connected to the projector, such as a computer and DVD player, you can switch from one image source to the other.

- 1** Make sure the connected image source you want to use is turned on.
- 2** For video image sources, insert a DVD or other video media and press play.
- 3** Press the  button on the remote control.
- 4** Press the up or down arrow button to select the image source you want.



When no image signal is detected, check the cable connections between the projector and the image source.

The projector can display images in different width-to-height ratios called aspect ratios. Normally, the input signal from your video source determines the image's aspect ratio. However, you can change the aspect ratio for certain images to fit your screen.

If you always want to use a particular aspect ratio for a certain video input source, you can select it using the projector's **Screen** menu.





You can select this setting only when the current input source is HDMI.

## ► Related Links

- "Changing the Image Aspect Ratio" [p.40](#)
- "Available Image Aspect Ratios" [p.40](#)

## Changing the Image Aspect Ratio

You can change the aspect ratio of the displayed image.

- 1** Turn on the projector and display an image.
- 2** Press the  button on the remote control to open the dashboard.
- 3** Select  on the dashboard.
- 4** Select the menus in the following order:  
☛ **Display & Sound > Screen**
- 5** Select one of the available aspect ratios for your input signal.
- 6** Press  to exit the menus.

## Available Image Aspect Ratios

You can select the following image aspect ratios.



Note that using the aspect ratio function of the projector to reduce, enlarge, or split the projected image for commercial purposes or for public viewing may infringe upon the rights of the copyright holder of that image based on copyright law.

Aspect mode	Description
Super Zoom	Zooms into images. The right, left, top, and bottom edges are missing.
4:3	Scales images to 4:3.
Movie expand 14:9	Scales images to 14:9.
Movie expand 16:9	Scales images to 16:9.
Full	Displays images using the full size of the projection area.
Unscaled	Displays images as they are.

The projector offers different color modes to provide optimum brightness, contrast, and color for a variety of viewing environments and image types. You can select the mode designed to match your image and environment, or experiment with the available modes.



## ► Related Links

- "Changing the Color Mode" [p.41](#)
- "Available Color Modes" [p.41](#)

---

## Changing the Color Mode

You can change the projector's color mode to optimize the image for your viewing environment.

- 1** Turn on the projector and display an image.
- 2** Press the  button on the remote control to open the dashboard.
- 3** Select  on the dashboard.
- 4** Select the menus in the following order:  
☛ **Display & Sound > Display > Picture Mode**
- 5** Select the color mode you want to use from the list.
- 6** Press  to exit the menus.

---

## Available Color Modes

You can set the projector to use these color modes, depending on your environment and image types.

Color mode	Description
Dynamic	This is the brightest mode. Best for prioritizing brightness.
Standard	This is a standard mode that balances brightness and color saturation. <b>Standard</b> mode is generally recommended.
Cinema	Best for enjoying content such as movies.
Natural	Reproduces natural colors. This is the best option when you want to adjust the image color.

The projector's **Display** menu provides several options for adjusting the quality of your image based on the input source you are currently using. You can fine-tune various aspects of how quality and colors are displayed in your projected images.



☛ **Display & Sound > Display**

See "Display & Sound Menu" for details on adjusting the image quality.

#### ▶ **Related Links**

- "Image Quality Settings - Display & Sound Menu" [p.59](#)



You can turn on **Dynamic Contrast** to automatically optimize the image luminance. This improves the image contrast based on the brightness of the content you project.

- 1** Turn on the projector and display an image.
- 2** Press the  button on the remote control to open the dashboard.
- 3** Select  on the dashboard.
- 4** Select the menus in the following order:  
☛ **Display & Sound > Display > Advanced Settings > Dynamic Contrast**
- 5** Select one of the following options:
  - **Off** if you do not want to adjust the brightness.
  - **Normal** for standard brightness adjustment.
  - **High Speed** to adjust brightness as soon as the scene changes.
- 6** Press  to exit the menus.

## ▶▶ Related Links

- "Image Quality Settings - Display & Sound Menu" [p.59](#)

You can adjust the brightness of your projector's light source.

- 1** Turn on the projector and display an image.
- 2** Press the  up/down buttons on the remote control.  
The **Light Output** adjustment gauge is displayed.
- 3** Press the  up/down buttons to adjust the brightness.
- 4** Press  to exit the menus.

The volume buttons control the projector's internal speaker system.

You can also control the volume of any external speakers you connected to the projector.

You must adjust the volume separately for each connected input source.



To adjust the volume for the connected audio/video system, set the **Global CEC control** setting to **On** in the projector's menu.

☛ **Channels & Inputs > Inputs > Global CEC control**

- 1** Turn on the projector and start a video.
- 2** To lower or raise the volume, press the  up/down buttons on the remote control.  
A volume gauge appears on the screen.

## **Caution**

Do not start a playback at a high volume setting. Sudden loud noises may cause hearing loss.



Always lower the volume before powering off, so that you can power on and then gradually increase the volume.

## ▶ **Related Links**

- "Projector Feature Settings - Channels & Inputs Menu" [p.57](#)

The projector offers different sound modes to provide optimum sound for a variety of image types.

You can select the mode designed to match your image, or experiment with the available modes.

- 1** Turn on the projector and start a video.
- 2** Press the  button on the remote control to open the dashboard.
- 3** Select  on the dashboard.
- 4** Select the menus in the following order:  
☛ Display & Sound > Sound > Sound Mode
- 5** Select your sound mode.
- 6** Press  to exit the menus.

## ▶▶ Related Links

- "Available Sound Modes" [p.46](#)

Sound mode	Description
Standard	Outputs the audio using normal sound quality.

---

## Available Sound Modes

You can set the projector to use these sound modes, depending on the input source you are using:

Sound mode	Description
Cinema	Best for audio from videos or movies. Low and high pitch sounds are emphasized.
Dialogue	Best for hearing voices and spoken lines.
Music	Best for music. Low and high pitch sounds are clearer.

# Adjusting Projector Features

Follow the instructions in these sections to use your projector's adjustment features.

## ► Related Links

- "Using the Projector as a Bluetooth® Speaker" [p.48](#)
- "Shutting Off the Image Temporarily" [p.49](#)
- "Using Google Cast™" [p.50](#)
- "HDMI CEC Features" [p.51](#)
- "Installing a Security Cable" [p.52](#)
- "Updating Projector Firmware Using Epson Projector Update" [p.53](#)
- "Initializing the Projector" [p.54](#)

You can use the projector's speaker to output audio from a video/audio device connected by Bluetooth.

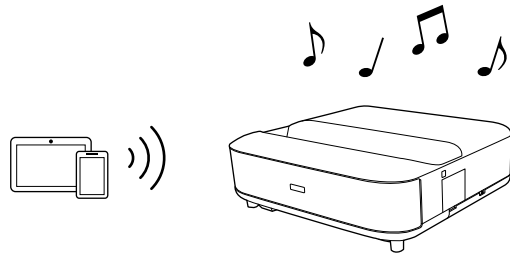

- 1** Turn on the projector and display an image.
- 2** Press the  button on the remote control to open the **Projector** menu.
- 3** Select **Bluetooth Speaker Mode**.  
The **Bluetooth Speaker Mode** screen is displayed.
- 4** Enable the Bluetooth function on the device you want to connect and select the projector name (this projector) from the available device list. See the documentation supplied with the device for more information.



- You can check and change the projector name from the projector's **Device name** menu.
  -  **System > About > Device name**
- To cancel a Bluetooth connection, disconnect from the connected device.

The projected image turns off 10 seconds after the Bluetooth connection is established.

- 5** To exit **Bluetooth Speaker Mode**, press the  button.







- There is a delay in the audio output from any Bluetooth audio device.
- You cannot connect multiple video/audio devices by Bluetooth at the same time.
- You can also connect the projector to Bluetooth audio devices, such as speakers or headphones, to output the projector's audio from these devices. Select the menus in the following order to perform pairing from the menu displayed.
  -  **Remotes & Accessories > Pair Accessory**
- Bluetooth audio devices are not supported in some countries and regions.

#### ▶▶ Related Links

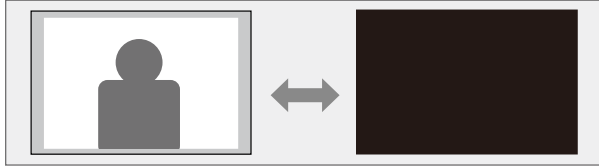
- "Bluetooth Specifications" [p.92](#)

You can temporarily turn off the projected image.



- 1** Press the  button on the remote control to open the dashboard.
- 2** Select  on the dashboard.
- 3** Select the menus in the following order:
  -  **Display & Sound > Display > Advanced Settings**
- 4** Select **Picture off** to turn off the projected image.
- 5** To turn the image back on, press .

#### ▶▶ Related Links

- "Image Quality Settings - Display & Sound Menu" [p.59](#)

With Google Cast, you can stream entertainment from your favorite apps on your phone, tablet or laptop to Epson projectors.

- 1** Connect your device or computer to the same wireless network as the projector.
- 2** Open the Google Cast-enabled app and press .
- 3** Select your projector from the list of devices.



You can check and change the projector name from the projector's **Device name** menu.

 **System > About > Device name**

The app connects and starts casting to the projector.

- 4** To stop casting, press  in the app and choose the disconnect option.

When an audio/video source that meets the HDMI CEC standard is connected to the projector's HDMI port, you can use the projector's remote control to control certain features of the linked device.

## ▶ Related Links

- "Operating Connected Devices Using the HDMI CEC Features" [p.51](#)

## Operating Connected Devices Using the HDMI CEC Features

You can control connected audio/video devices using the HDMI CEC features.



- You must also configure the connected device. See the documentation supplied with the device for more information.
- Some connected devices or functions of those devices may not operate properly even if they meet the HDMI CEC standard. See the documentation supplied with the device for more information.
- Use a cable that supports the HDMI standard.

**1** Press the  button on the remote control to open the dashboard.

**2** Select  on the dashboard.

**3** Select the menus in the following order:  
 **Channels & Inputs > Inputs > Global CEC control**

**4** Set **Global CEC control** to on.

**5** Adjust the following HDMI CEC settings as necessary.

- To automatically turn off the connected device when you turn off the projector, set **Allow TV to turn off connected devices** to on.

- To automatically turn on the projector when you turn on the connected device, set **Allow connected devices to turn on TV** to on.

**6** Press  to exit the menus.

You can use the projector's remote control to control the linked device such as playback, stop, or adjust the volume.

## ▶ Related Links

- "Projector Feature Settings - Channels & Inputs Menu" [p.57](#)

You can use the security slot on the projector to attach a Kensington Microsaver Security system as a theft deterrent.



For more details on the Microsaver Security System, see <http://www.kensington.com/>.

## ▶▶ Related Links

- "Projector Parts - Top/Side" [p.11](#)

You can get the latest version of the projector firmware by using Epson Projector Update.



- If the Epson Projector Update app is not installed, install it from the home screen. Be sure to install the app to keep the projector up to date.
- When the latest projector firmware is available, a notification is automatically displayed on the screen. Follow the on-screen instructions to update the firmware.
- If there is not enough space in the internal storage, the update may fail. Free up space by deleting unnecessary apps and caches, then try updating again.

**3** Follow the on-screen instructions to update the firmware.

**Attention**

While updating the firmware, do not operate or turn off the projector.

▶▶ **Related Links**

- "Installing Epson Projector Update" [p.28](#)

**1** Press the  button on the remote control.

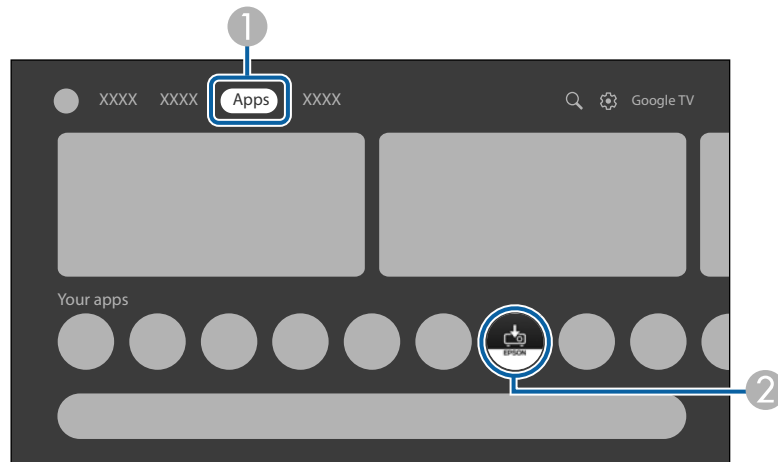

**2** Select **Apps** and start **Epson Projector Update** by selecting it from the apps list.



You can reset all of the projector settings to their default values.



If you initialize the projector, all the information such as installed apps, Google Account login information, and the projector's menu settings are deleted. Write down the settings you do not want to lose before performing initialization.

- 1** Turn on the projector and display an image.
- 2** Press the  button on the remote control to open the dashboard.
- 3** Select  on the dashboard.
- 4** Select the menus in the following order:  
 **System > About > Reset > Factory reset**
- 5** Follow the on-screen instructions to start initializing the projector.

## ▶ Related Links

- "System Menu" [p.61](#)





# Adjusting the Menu Settings

Follow the instructions in these sections to access the projector menu system and change projector settings.

## ► Related Links

- "Using the Projector's Menus" [p.56](#)
- "Projector Feature Settings - Channels & Inputs Menu" [p.57](#)
- "Projector Feature Settings - Projector Menu" [p.58](#)
- "Image Quality Settings - Display & Sound Menu" [p.59](#)
- "Other Menus" [p.61](#)

You can use the projector's menus to adjust the settings that control how your projector works. The projector displays the menus on the screen.

- 1** Press the  button on the remote control to open the dashboard.
- 2** Select  on the dashboard.
- 3** Press the up or down arrow buttons to move through the menus listed on the screen.
- 4** To change settings in the displayed menu, press the [Enter] button.
- 5** Press the arrow buttons to move through the settings.
- 6** Change the settings using the buttons as necessary.
- 7** When you finish changing settings on a menu, press .
- 8** Press  to exit the menus.

Settings on the **Channels & Inputs** menu let you control the audio/video device you are currently using.

►► **Related Links**

- "Operating Connected Devices Using the HDMI CEC Features" [p.51](#)

Setting	Options	Description
Inputs	Switch input	Switches the input source between <b>Home</b> and <b>HDMI</b> .
	HDMI1 HDMI2 HDMI3	<p><b>Show this input:</b> Specifies whether to show <b>HDMI1/HDMI2/HDMI3</b> in the list of input sources.</p> <p><b>PIN lock:</b> When enabling this setting, the PIN code of the device that is connected to the projector's HDMI port is required when you switch the input source to <b>HDMI</b>.</p> <p><b>Edit names:</b> Selects a name you want to display as the name of the audio/video device that is connected to the projector's HDMI port.</p> <p><b>No signal standby timeout:</b> Sets the time before the projector enters standby mode when no signal is detected from the <b>HDMI</b> source.</p> <p><b>HDMI EDID Version:</b> Displays the EDID version.</p>
	Global CEC control	Select <b>On</b> to control the connected audio/video device using the projector's remote control.
	Allow TV to turn off connected devices	Select <b>On</b> to automatically turn off the connected audio/video device when you turn off the projector.
	Allow connected devices to turn on TV	Select <b>On</b> to automatically turn on the projector when you turn on the connected device, or when you start playback on the connected device.

Settings on the **Projector** menu provide correction methods to properly project your image.

Setting	Options	Description
Keystone	—	Provides on-screen instructions for correcting distortion in the projected image.  You can select the correction method by using the Epson Setting Assist app or by using the remote control.
Zoom & Shift	—	Resizes the projected image and adjusts the image position.
Advanced Settings	Smart Eye Protection	Select <b>On</b> to enable the <b>Smart Eye Protection</b> function.  When the projector's sensor detects obstacles that are interfering with the projection area, the brightness of the light source is automatically reduced to minimize glare.
	Projection	Selects the way the projector faces the screen so the image is oriented correctly.
	Indicators	Set to <b>Off</b> to turn off the indicator lights on the projector except when an error or warning occurs.
	High Altitude Mode	Set to <b>On</b> to regulate the projector's operating temperature at altitudes above 1,500 m.
	Panel Alignment	Corrects color misalignment in the projected image.
Bluetooth Speaker Mode	—	Opens the Bluetooth device connection screen to switch to <b>Bluetooth Speaker Mode</b> .

►► **Related Links**

- "Correcting Distortion in the Image" [p.34](#)
- "Adjusting the Size and Position of the Image" [p.38](#)
- "Using the Projector as a Bluetooth® Speaker" [p.48](#)
- "Adjusting the Color Convergence (Panel Alignment)" [p.71](#)

Settings on the **Display & Sound** menu let you adjust the quality of your image and optimize the sound for the input source you are currently using.

Setting	Options	Description
Display	Picture Mode	Select your favorite color mode from the list.
	Light Output	Adjusts the brightness of the light source. You cannot adjust the brightness if the brightness of the light source dims because the surrounding temperature is too high or for other factors.
	Brightness	Lightens or darkens the overall image.
	Contrast	Adjusts the difference between light and dark areas of the image.
	Saturation	Adjusts the overall vividness of the color.
	Tint	Adjusts the balance of green to magenta tones in the image.
	Sharpness	Adjusts the sharpness or softness of the image.
	Advanced Settings	See the table below for details.
	Reset to Default	Resets all adjustment values on the <b>Display</b> menu to their default settings.
Screen	See the list of available aspect ratios.	Sets the aspect ratio (width-to-height ratio) for the input source. (This setting is available only when the current input source is HDMI.)
Sound	Sound Mode	Select your favorite mode for sound output from the projector's speaker system according to the playback contents.
	Reset to Default	Resets all adjustment values on the <b>Sound</b> menu to their default settings.

Setting	Options	Description
Audio Output	Digital Output	Selects the sound output format when you output audio to an external audio device.
	Digital Output Delay	Adjusts the audio latency. If the audio is fast, select a higher value.
	Audio Output Device	Select <b>SPDIF</b> to output audio only from an audio/video system connected to the projector's Optical Out port. No audio is output from the projector's speakers.

### Advanced Settings

Setting	Description
Picture off	Turns off the projected image.
Color Temperature	Sets the color temperature according to the color mode you selected.
DNR	Reduces flickering in images.
MPEG NR	Reduces the noise or artifacts seen in MPEG video.
Projection Preferences	Selects whether to prioritize brightness or color tone when projecting an image. <ul style="list-style-type: none"> <li>• <b>Fine:</b> Prioritizes color tone.</li> <li>• <b>Bright:</b> Prioritizes brightness.</li> </ul>
Dynamic Contrast	Adjusts the projected luminance based on the image brightness.
Scene Adaptive Gamma	Adjusts the coloring according to the scene, and obtains a more vivid image. Higher values enhance the more the contrast.
Local Contrast Control	Enhances the contrast of the projected image.
Dynamic Color Booster	Automatically adjusts saturation according to the scene and makes the projected image colorful.
Flesh Tone	Lightens the skin tone of the image.

Setting	Description
Gamma	Selects the gamma to adjust the coloring.
Game Mode	Improves the response speed for images projected at high speed, such as games. This setting is displayed only when: <ul style="list-style-type: none"> <li>• ALLM is set to Off.</li> <li>• <b>Frame Interpolation</b> is set to Off.</li> </ul>
ALLM	Automatically adjusts the response speed according to your projected content.
PC Mode	Select <b>On</b> to project the image while preserving the color information of the input image signal. This setting is available only when the current input source is <b>HDMI</b> .
Frame Interpolation	Adjusts the smoothness of image movement. This setting is displayed only when: <ul style="list-style-type: none"> <li>• <b>Game Mode</b> is set to Off.</li> <li>• <b>PC Mode</b> is set to Off.</li> </ul>
AISR	Highlights the sharpness of the image by using image analysis with AI technology.
De-contour	Reduces banding noise in the image.
Low Blue Light	Reduces blue light in the projected image.
Color Tuner	Set <b>Enable</b> to <b>On</b> to enable the <b>Color Tuner</b> settings. Adjusts the individual R (red), G (green), B (blue), C (cyan), M (magenta), Y (yellow), and <b>Flesh Tone</b> components of the <b>Hue</b> , <b>Saturation</b> , and <b>Brightness</b> settings.  Adjusts the individual R (red), G (green), and B (blue) components of the offset and gain.
AIPQ	Analyzes the image for each scene and applies suitable image correction based on the picture database in the projector's chip.

Setting	Description
HDMI RGB Range	Sets the video range to match the setting of the device connected to the HDMI port.

►► **Related Links**

- "Adjusting Image Quality (Color Mode)" [p.41](#)
- "Adjusting Image Quality in Detail" [p.42](#)
- "Adjusting the Light Source Brightness" [p.44](#)
- "Image Aspect Ratio" [p.40](#)
- "Changing the Sound Mode" [p.46](#)

Options on other menus let you customize various projector's OS features.

#### ► Related Links

- "Network & Internet Menu" [p.61](#)
- "Accounts & Profiles Menu" [p.61](#)
- "Privacy Menu" [p.61](#)
- "Apps Menu" [p.61](#)
- "System Menu" [p.61](#)
- "Accessibility Menu" [p.61](#)
- "Remotes & Accessories Menu" [p.62](#)
- "Help & Feedback Menu" [p.62](#)

## Network & Internet Menu

Settings on the **Network & Internet** menu let you view network information and set up the projector for controlling over a network.

## Accounts & Profiles Menu

Settings on the **Accounts & Profiles** menu let you add new Google Accounts used to log in to the projector, and make detailed settings for these accounts.

## Privacy Menu

Settings on the **Privacy** menu let you change your privacy and security settings.

## Apps Menu

The **Apps** menu displays your most recently used apps or all the apps that are installed on the projector.

## System Menu

Settings on the **System** menu let you customize various projector features.

Setting	Description
Ambient Screensaver	Allows you to make settings for the screen saver.
Power & Energy	Allows you to make settings for power and energy saving.
About	Displays the projector's preferences and status. You can return all the projector settings to their factory default values from this menu.
Date & Time	Adjusts the projector's system time and date settings.
Language	Select the language used for the projector menus and messages.
Keyboard	Allows you to make detailed settings for the virtual keyboard installed in the projector's menu.
Storage	Allows you to display the usage status of the internal storage and clean the cache.
Cast	Turns on/off the cast function.
System sounds	Turns on/off the system sounds.
Restart	Restarts the projector.

#### ► Related Links

- "Initializing the Projector" [p.54](#)

## Accessibility Menu

Settings on the **Accessibility** menu let you configure accessibility options, such as subtitles and text reading.

---

## Remotes & Accessories Menu

Settings on the **Remotes & Accessories** menu let you pair the remote control and the projector, or let you connect/disconnect your Bluetooth devices to the projector.

---

## Help & Feedback Menu

The **Help & Feedback** menu provides a link to the projector's OS help page, or lets you send feedback or comments about the product.

# Maintaining the Projector

Follow the instructions in these sections to maintain your projector.

## ► Related Links

- "Projector Maintenance" [p.64](#)
- "Cleaning the Projection Window" [p.65](#)
- "Cleaning the Motion Sensor" [p.66](#)
- "Cleaning the Projector Case" [p.67](#)
- "Air Filter and Air Intake Vent Maintenance" [p.68](#)
- "Adjusting the Color Convergence (Panel Alignment)" [p.71](#)

You may need to clean the projection window and motion sensor periodically, and clean the air filter and air vents to prevent the projector from overheating due to blocked ventilation.

The only parts you should replace are the air filter and remote control batteries. If any other part needs replacing, contact Epson or an authorized Epson servicer.

 **Warning**

Before cleaning any part of the projector, turn it off and unplug the power cord. Never open any cover on the projector, except as specifically explained in this manual. Dangerous electrical voltages in the projector can injure you severely.

Clean the projection window periodically, or whenever you notice dust or smudges on the surface.

- To remove dust or smudges, gently wipe the projection window with clean and dry lens-cleaning paper.
- If the projection window is dusty, blow off dust using a blower, and then wipe the projection window.

## **Warning**

- Before cleaning the projection window, turn off the projector and unplug the power cord.
- Do not use any flammable gas sprays such as air dusters to blow off dust. The high heat generated by the projector may cause a fire.

## **Attention**

- Do not wipe the projection window right after you turn off the projector. Doing so could damage the projection window.
- Do not use any harsh materials to clean the projection window and do not subject the projection window to any impacts; otherwise, it could be damaged.

Clean the projector's motion sensor periodically, or if you see a message telling you to remove any obstacles that are interfering with the projection area. To remove dust or smudges, gently wipe the sensors with lens-cleaning paper.

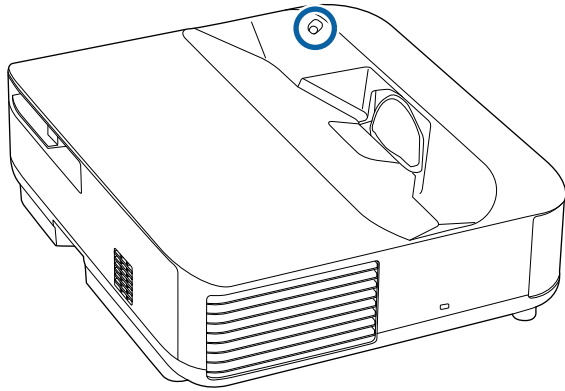

## **Warning**

Do not use a lens cleaner that contains flammable gas to clean the motion sensor. The high heat generated by the projector may cause a fire.

## **Attention**

Do not use glass cleaner or any harsh materials to clean the sensors and do not subject the sensors to any impacts. Damage to the surface of the sensors may cause malfunctions.

Before cleaning the projector case, turn off the projector and unplug the power cord.

- To remove dust or dirt, use a soft, dry, lint-free cloth.
- To remove stubborn dirt, use a soft cloth moistened with water and mild soap. Do not spray liquid directly on the projector.

### **Attention**

Do not use wax, alcohol, benzene, paint thinner, or other chemicals to clean the projector case. These can damage the case. Do not use canned air, or the gases may leave a flammable residue.

Regular filter maintenance is important to maintain your projector. Clean the air filter when a message appears telling you the temperature inside the projector has reached a high level. It is recommended that you clean these parts about once every year. Clean them more often than this if you use the projector in an environment that is dustier than expected. (Assuming the projector is used in an atmosphere in which airborne particulate matter is less than 0.04 to 0.2 mg/m<sup>3</sup>.)

## Attention

If regular maintenance is not performed, your Epson projector will notify you when the temperature inside the projector has reached a high level. Do not wait until this warning appears to maintain your projector filter as prolonged exposure to high temperatures may reduce the life of your projector.

### ► Related Links

- "Cleaning the Air Filter" [p.68](#)
- "Replacing the Air Filter" [p.69](#)
- "Cleaning the Air Intake Vents" [p.70](#)

## Cleaning the Air Filter

You need to clean the projector's air filters in the following situations:

- The filter or vents get dusty.

**1** Turn off the projector and unplug the power cord.

**2** Slide the air filter cover latch and pull out the air filter cover.

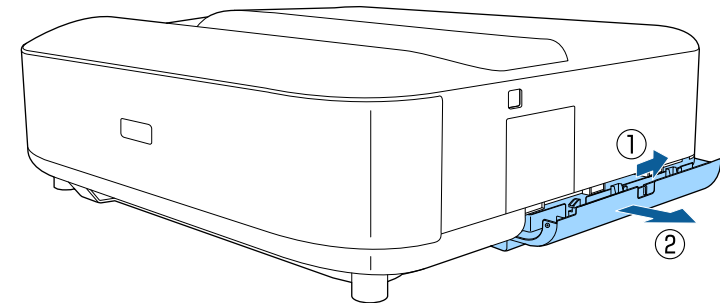

**3** Pull the air filter out of the air filter cover.

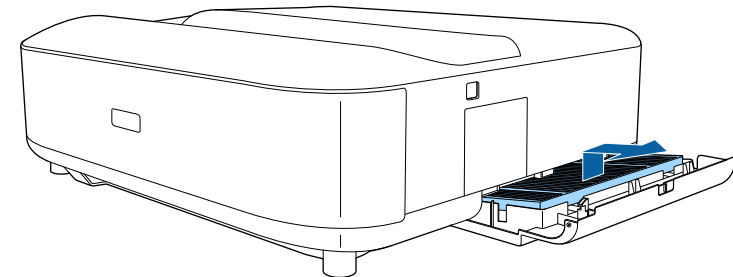

**4** Vacuum the front of the air filter (the side with the tabs) to remove any remaining dust.

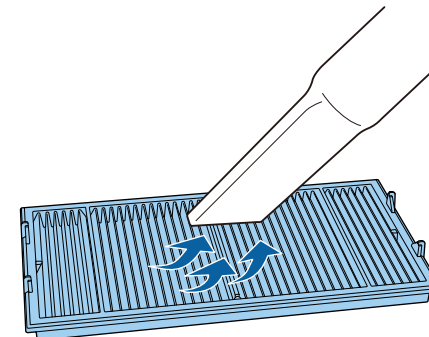

## Attention

- Do not rinse the air filter in water, or use any detergent or solvent to clean it.
- Do not use canned air. The gases may leave a flammable residue or push dust and debris into the projector's optics or other sensitive areas.

- 5** Place the air filter with the four tabs facing down as shown.

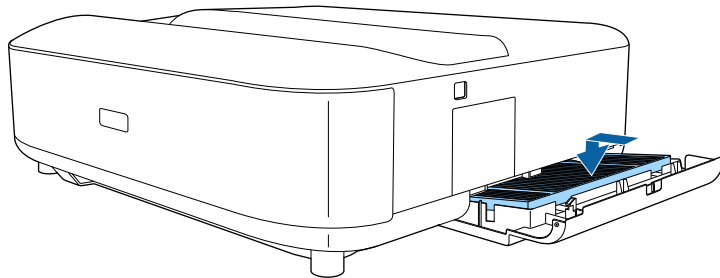

## Attention

Do not force the air filter cover to close with the tabs on the air filter facing up. Doing so could damage the projector.

- 6** Close the air filter cover until it clicks into place.

## Replacing the Air Filter

You need to replace the air filter in the following situations:

- The air filter is torn or damaged.

- 1** Turn off the projector and unplug the power cord.

- 2** Slide the air filter cover latch and open the air filter cover.

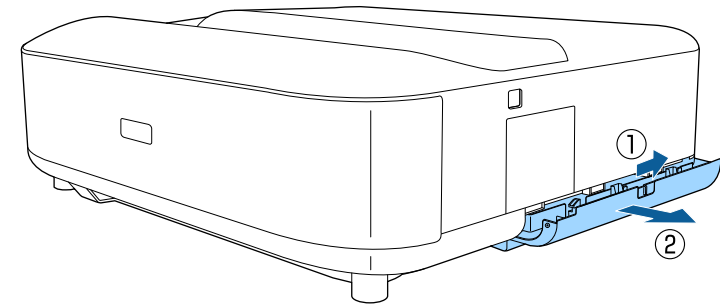

- 3** Pull the air filter out of the projector.

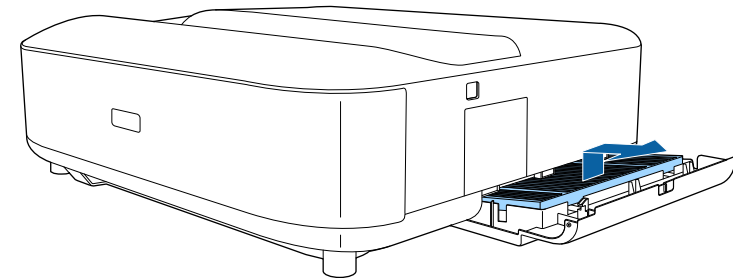

Dispose of used air filters according to local regulations.

- Filter frame: Polypropylene
- Filter: Polypropylene, PET

- 4 Place the new air filter with the four tabs facing down as shown.

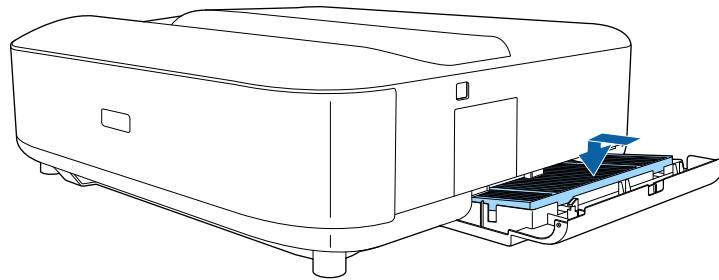

**Attention**

Do not force the air filter cover to close with the tabs on the air filter facing up. Doing so could damage the projector.

- 5 Close the air filter cover until it clicks into place.

► **Related Links**

- "Replacement Parts" [p.88](#)

- 3 Carefully remove the dust using a vacuum cleaner or a brush.

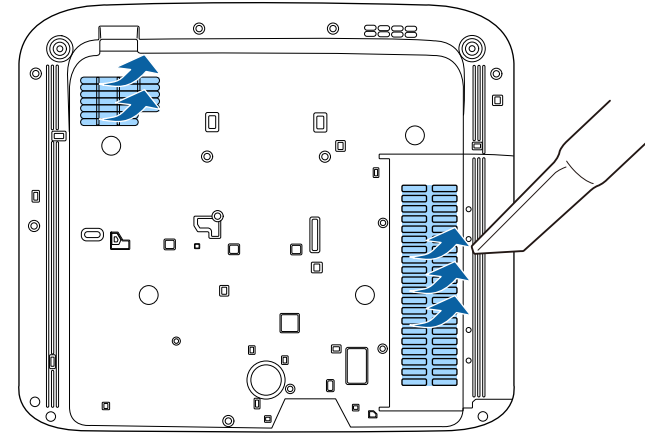

---

## Cleaning the Air Intake Vents

Clean the projector's air intake vents periodically, or whenever you notice dust on the surface of the vents to prevent the projector from overheating due to blocked ventilation.

- 1 Turn off the projector and unplug the power cord.
- 2 Turn the projector upside down.

You can use the Panel Alignment feature to manually adjust the color convergence (the alignment of the red and blue colors) in the projected image. You can adjust the pixels horizontally and vertically in increments of 0.125 pixels within a range of  $\pm 3$  pixels.



- You can adjust only the red or blue color convergence. Green is the standard color panel and cannot be adjusted.
- Image quality may decline after performing Panel Alignment.
- Images for pixels that extend beyond the edge of the projected screen are not displayed.

**1** Press the  button on the remote control to open the **Projector** menu.

**2** Select the menus in the following order:  
☛ **Advanced Settings > Panel Alignment**

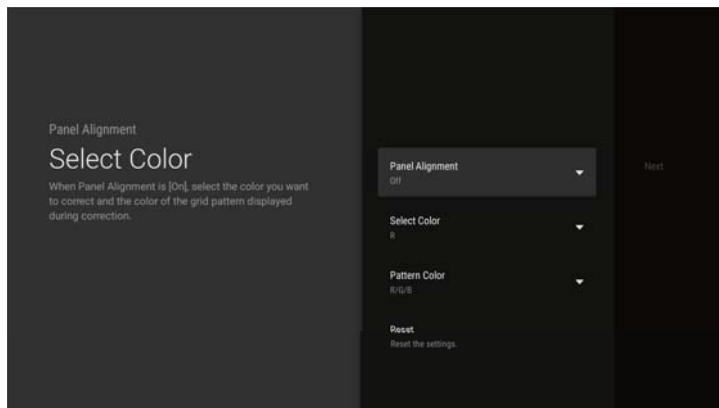

**3** Select **Panel Alignment** and set it to **On**.

**4** Select **Select Color** and choose one of the following:

- **R** to adjust the red color convergence.

- **B** to adjust the blue color convergence.

**5** Select **Pattern Color** and choose the grid color displayed when making adjustments. The available color varies depending on the **Select Color** setting.

- **R/G/B** to display the grid color in white.
- **R/G** to display the grid color in yellow. **R/G** is only displayed when **Select Color** is set to **R**.
- **G/B** to display the grid color in cyan. **G/B** is only displayed when **Select Color** is set to **B**.

**6** Select **Next**.

**7** Select one of the following options on the **Select Method** screen:

- Select **Whole Panel** to adjust the entire panel at the same time and go to the next step.
- Select **Four Corners** to adjust the corners of the panel one at a time and go to step 11.

**8** Use the arrow buttons on the remote control to adjust the color alignment selected in **Select Color**, and then press [Enter].



Adjustment affects the grid lines in the entire screen.

**9** Select one of the following options:

- Select **Adjust the four corners** to fine-tune your adjustments.
- Select **Exit** to finish adjustments.

**10** Use the arrow buttons on the remote control to adjust the color alignment of the screen corner, and then press [Enter].

**11** When you are finished adjusting each corner of the screen, press [Enter].

**12** Select one of the following options:

- If your projector needs additional panel alignment, select **Fine Adjustment**. Use the arrow buttons on the remote control to highlight the corner of any misaligned box on the screen, press [Enter], make any necessary adjustments, and then press [Enter] again. Repeat this step as necessary for the other intersections.
- Select **Exit** to finish adjustments.

# Solving Problems

Check the solutions in these sections if you have any problems using the projector.

## ► Related Links

- "Projection Problems" [p.74](#)
- "Projector Indicator Status " [p.75](#)
- "Solving Projector Power-On or Power-Off Problems" [p.77](#)
- "Solving Image Problems" [p.78](#)
- "Solving Sound Problems" [p.81](#)
- "Solving Remote Control Operation Problems" [p.83](#)
- "Solving HDMI CEC Problems" [p.84](#)
- "Solving Wi-Fi Network Problems" [p.85](#)
- "Solving Projector's OS Problems" [p.86](#)

If the projector is not working properly, turn it off, unplug it, and then plug it back in and turn it on.

If this does not solve the problem, check the following:

- The indicators on the projector may indicate the problem.
- The solutions in this manual can help you solve many problems.

If none of these solutions help, contact Epson for technical support.



After repairing the projector, Epson may return the projector to you in its initial status. Make sure you make a note of the account information of each online service before you contact your local dealer or the nearest Epson repair center.

The indicators on the projector indicate the projector status and let you know when a problem occurs. Check the status and color of the indicators and then refer to this table for a solution.



If the indicators display a pattern not listed in the table below, turn the projector off, unplug it, and contact Epson for help.

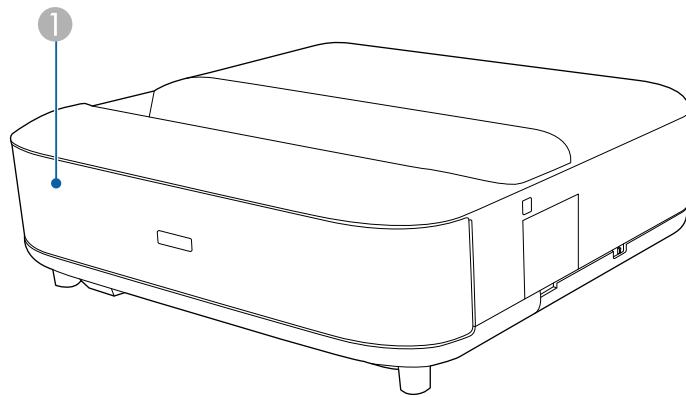

1 Status indicator

### Projector status

Indicator status/ Operation status	Problem and solutions
Lit white (Normal operation) The projector can display images.	-

Indicator status/ Operation status	Problem and solutions
Flashing white (Entering standby mode or updating the projector firmware) When the firmware update starts, a message is displayed on the screen.	Remote control operations may be disabled when the indicator is flashing white.
Off (Standby mode)	When you press the power button, projection starts.
Lit orange (Warning status) You can check the details of the warning on the screen.	<p>The projector has overheated and turned off. Leave it turned off to cool down for 5 minutes.</p> <ul style="list-style-type: none"> <li>• Make sure that the vents and air filter are not clogged with dust or obstructed by nearby objects.</li> <li>• Make sure the environmental temperature is not too hot.</li> <li>• Clean or replace the air filter.</li> <li>• If operating the projector at high altitude, set the <b>High Altitude Mode</b> setting to <b>On</b> in the projector's menu.  <b>Projector &gt; Advanced Settings &gt; High Altitude Mode</b></li> <li>• If the problem persists, unplug the projector and contact Epson for help.</li> </ul>

Indicator status/ Operation status	Problem and solutions
	<p>Movement detection warning. A beep sounds, and the following message is displayed. <b>Playback has been stopped for safety reasons. Move away from the lens or remove any obstacles around the lens.</b></p> <p>The brightness of the light source is reduced.</p> <ul style="list-style-type: none"> <li>• Make sure that there are no one looking into the projection window. Move away from the projection window.</li> <li>• Clean the motion sensor if there is no one near the projection window.</li> </ul>
<p>Flashing orange (Error status) You cannot turn on the projector.</p>	<p>Laser has a problem. Turn the projector off, unplug it, and contact Epson for help.</p> <p>A fan or sensor has a problem. Turn the projector off, unplug it, and contact Epson for help.</p> <p>Internal projector error. Turn the projector off, unplug it, and contact Epson for help.</p>

► **Related Links**

- "Projector Feature Settings - Projector Menu" [p.58](#)
- "Cleaning the Air Filter " [p.68](#)
- "Replacing the Air Filter" [p.69](#)
- "Cleaning the Air Intake Vents " [p.70](#)

Check the solutions in these sections if the projector does not turn on when you press the power button or it turns off unexpectedly.

## ▶▶ Related Links

- "Solving Projector Power Problems" [p.77](#)
- "Solving Projector Shutdown Problems" [p.77](#)

---

## Solving Projector Power Problems

If the projector does not turn on when you press the power button, try the following steps until the problem is solved.

- 1** Make sure the power cord is securely connected to the projector and to a working electrical outlet.
- 2** If you are using the remote control, check the batteries of the remote control.
- 3** The power cord may be defective. Disconnect the cord and contact Epson for help.

## ▶▶ Related Links

- "Turning On the Projector" [p.30](#)
- "Installing Batteries in the Remote Control" [p.24](#)

---

## Solving Projector Shutdown Problems

If the projector's light source turns off unexpectedly, try the following steps until the problem is solved.

- 1** The projector may have turned off after the interval of time specified in **Shut-Off Timer** in the projector's **Power & Energy** menu has passed. Press the power button on the projector or remote control to turn the projector back on.

☛ **System > Power & Energy > Shut-Off Timer**

- 2** After switching to HDMI source, if there is no input signal for more than the time specified in **No signal standby timeout**, the projector automatically enters standby mode. Press the power button to wake the projector from standby mode.

☛ **Channels & Inputs > Inputs > HDMI 1/HDMI 2/HDMI 3 > No signal standby timeout**

- 3** When the status indicator is lit orange, the projector has overheated and turned off.



The cooling fans may run in standby status depending on the projector settings. Also, when the projector wakes from standby status, the fans may cause an unexpected noise. This is not a malfunction.

- 4** Make sure that there are no obstacles interfering with the projection window. Remove any obstacles.

## ▶▶ Related Links

- "Projector Feature Settings - Channels & Inputs Menu" [p.57](#)
- "System Menu" [p.61](#)

Check the solutions in these sections if you have any problems with projected images.

## ► Related Links

- "Solving Missing Image Problems" [p.78](#)
- "Adjusting an Image that is not Rectangular" [p.79](#)
- "Adjusting a Fuzzy or Blurry Image" [p.79](#)
- "Fixing Partial Image Problems" [p.79](#)
- "Adjusting an Image that Contains Noise or Static" [p.80](#)
- "Adjusting an Image with Incorrect Brightness or Colors" [p.80](#)

---

## Solving Missing Image Problems

If no image is displayed, try the following steps until the problem is solved.

- 1** Check the projector's status:
  - Check the status indicator to confirm that the projector is in normal operating status.
  - Press the projector's power button to wake it from standby mode.
  - After switching to an HDMI source, if there is no input signal for more than the time specified in **No signal standby timeout**, the projector automatically enters standby mode. Press the power button to wake the projector from standby mode.
    - ☛ **Channels & Inputs > Inputs > HDMI 1/HDMI 2/HDMI 3 > No signal standby timeout**
- 2** Check the cable connection:
  - Make sure all necessary cables are securely connected and the power is on for the projector.
  - Connect the video source directly to the projector.
  - Replace the HDMI cable with a shorter one.

We recommend using an HDMI cable that is five meters or shorter. If you use an HDMI cable that is longer than five meters, the signal may deteriorate and the video and audio may become unstable.

- When sending 18 Gbps images such as 4K 60 Hz 4:4:4, use an HDMI cable (premium-high speed).

- 3** Check the status of your video source:
  - Turn on the connected video source, and press the play button to start a video, if necessary.
  - Make sure the connected device meets the HDMI CEC standard. See the documentation supplied with the device for more information.
  - If you are projecting from a laptop computer, make sure it is set up to display on an external monitor.
- 4** Check the following items:
  - You need an Internet connection to view online content. Make sure your Wi-Fi is on.
  - Turn off the projector and the connected video source, and then turn them back on.
  - Set the CEC function for the connected device again and restart the device.
  - Make sure the computer's display resolution does not exceed the projector's resolution and frequency limits. If necessary, select a different display resolution for your computer. (See your computer manual for details.)
  - Reset all of the projector settings to their default values.

## ► Related Links

- "Projector Feature Settings - Channels & Inputs Menu" [p.57](#)

## Adjusting an Image that is not Rectangular

If the projected image is not evenly rectangular, try the following steps until the problem is solved.

**1** Place the projector directly in front of the center of the screen, facing it squarely, if possible.

**2** Correct the distortion in the projected image using the projector's **Keystone** menu.

☛ **Projector > Keystone**

### ▶▶ Related Links

- "Correcting Distortion in the Image" [p.34](#)

## Adjusting a Fuzzy or Blurry Image

If the projected image is fuzzy or blurry, try the following steps until the problem is solved.

**1** Adjust the image focus using the focus lever.

**2** Position the projector close enough to the screen.

**3** Clean the projection window.



To avoid condensation on the lens after bringing the projector in from a cold environment, let the projector warm up to room temperature before using it.

**4** Adjust the **Sharpness** setting in the projector's **Display & Sound** menu to improve image quality.

☛ **Display & Sound > Display > Sharpness**

**5** If you are projecting from a computer, use a lower resolution or select a resolution that matches the projector's native resolution.

### ▶▶ Related Links

- "Focusing the Image Using the Focus Lever" [p.33](#)
- "Image Quality Settings - Display & Sound Menu" [p.59](#)
- "Cleaning the Projection Window" [p.65](#)

## Fixing Partial Image Problems

If only a partial image is displayed, try the following steps until the problem is solved.

**1** Adjust the position of the projected image using the **Zoom & Shift** setting in the **Projector** menu.

☛ **Projector > Zoom & Shift**

**2** Select an appropriate aspect ratio from the **Screen** menu according to the current input source. (Available only when the current input source is HDMI.)

☛ **Display & Sound > Screen**

**3** Check your computer display settings to disable dual display and set the resolution within the projector's limits. (See your computer manual for details.)

### ▶▶ Related Links

- "Adjusting the Size and Position of the Image" [p.38](#)
- "Changing the Image Aspect Ratio" [p.40](#)

## Adjusting an Image that Contains Noise or Static

If the projected image contains electronic interference (noise) or static, try the following steps until the problem is solved.

- 1** Check the cables connecting your video source to the projector. They should be:
  - Separated from the power cord to prevent interference
  - Securely connected at both ends
  - Not connected to an extension cable
- 2** Adjust the DNR setting in the projector's menu.  
☛ **Display & Sound > Display > Advanced Settings > DNR**
- 3** If you adjusted the image shape using the projector controls, try decreasing the **Sharpness** setting in the projector's **Display & Sound** menu to improve image quality.  
☛ **Display & Sound > Display > Sharpness**
- 4** If you connected an extension power cable, try projecting without it to see if it caused interference in the signal.
- 5** Select a computer video resolution and refresh rate that are compatible with the projector.
- 6** If you connected an A/V system that does not support eARC/ARC to the HDMI port, the image may be distorted.

### ▶▶ Related Links

- "Image Quality Settings - Display & Sound Menu" [p.59](#)

## Adjusting an Image with Incorrect Brightness or Colors

If the projected image is too dark or bright, or the colors are incorrect, try the following steps until the problem is solved.

- 1** Try different color modes for your image and environment by selecting the color mode setting in the projector's **Picture Mode** menu.  
☛ **Display & Sound > Display > Picture Mode**
- 2** Check your video source settings.
- 3** Adjust the color settings in the **Display** menu.  
☛ **Display & Sound > Display**
- 4** Make sure you selected the correct **HDMI RGB Range** setting in the projector's **Display & Sound** menu, if available for your image source. (Available only for the HDMI source.)  
☛ **Display & Sound > Display > Advanced Settings > HDMI RGB Range**
- 5** Make sure all the cables are securely connected to the projector and your video equipment. If you connected long cables, try connecting shorter cables.
- 6** Position the projector close enough to the screen.

### ▶▶ Related Links

- "Image Quality Settings - Display & Sound Menu" [p.59](#)



Check the solutions in these sections if you have any problems with projected sound.

## ► Related Links

- "Solving Missing or Low Audio Problems" [p.81](#)
- "Solving Bluetooth Speaker Mode Problems" [p.81](#)



## Solving Missing or Low Audio Problems

If there is no sound or the volume is too low, try the following steps until the problem is solved.

- 1** Adjust the projector's volume settings using the  up/down buttons on the remote control.
- 2** Check the cable connection between the projector and your video source.
- 3** Check your video source to make sure the volume is turned up and the audio output is set for the correct source.
- 4** If you want to output audio from the projector's speakers, check that **Global CEC control** is set to **Off**.  
 **Channels & Inputs > Inputs > Global CEC control**
- 5** If you want to output audio to an external audio device that supports HDMI eARC/ARC using an HDMI cable, try the following solutions:
  - Set **Global CEC control** to **On** in the projector's menu when using an ARC connection.  
 **Channels & Inputs > Inputs > Global CEC control**
  - Make sure the HDMI cable is compliant with HDMI eARC and ARC.



- When outputting audio to an external audio device that does not support HDMI eARC/ARC using an HDMI cable, set **Global CEC control** to **Off** in the projector's menu.  
 **Channels & Inputs > Inputs > Global CEC control**
- See the *Supplemental A/V Support Specification* for eARC/ARC audio supported formats.

- 6** If audio is not output properly to an external audio device that supports HDMI eARC/ARC, try changing **Auto** to **PCM** as the **Digital Output** setting.  
 **Display & Sound > Audio Output > Digital Output**
- 7** To output audio only from an external device connected to the projector's Optical Out port and not from the projector's speakers, set **Audio Output Device** to **SPDIF**.  
 **Display & Sound > Audio Output > Audio Output Device**

## ► Related Links

- "Projector Feature Settings - Channels & Inputs Menu" [p.57](#)
- "Image Quality Settings - Display & Sound Menu" [p.59](#)

## Solving Bluetooth Speaker Mode Problems

If you cannot connect a Bluetooth audio device to the projector, try the following solutions.

- 1** Select **Bluetooth Speaker Mode** in the **Projector** menu and press the [Enter] button on the remote control.

- 2 Select the projector name (this projector) from the list of available Bluetooth devices displayed on your device.



You can check and change the projector name from the projector's **Device name** menu.

☞ **System > About > Device name**

- 3 Check your Bluetooth audio device to make sure the volume is turned up and the audio output settings are correct.
- 4 Make sure only one Bluetooth device is connected to the projector.  
You cannot connect multiple Bluetooth audio devices to the projector at the same time.
- 5 Make sure the device meets the projector's Bluetooth specifications.
- 6 Check the following items:
  - Check for obstacles between the Bluetooth audio device and the projector, and change their positions to improve communication.
  - Make sure the connected Bluetooth audio device is within the specified communication distance.
  - Avoid using the projector near wireless networks, microwave ovens, 2.4 GHz cordless phones, or other devices that use the 2.4 GHz frequency band. These devices can interfere with the signal between the projector and the Bluetooth audio device.



## ► Related Links

- "Using the Projector as a Bluetooth® Speaker" [p.48](#)
- "Bluetooth Specifications" [p.92](#)

If the projector does not respond to remote control commands or responds slowly, try the following steps until the problem is solved.



If you lose the remote control, you can order another one. Contact Epson for help.

- 1** Check that the remote control batteries are installed correctly and have power. If necessary, replace the batteries.
- 2** The buttons on the remote control may be stuck down and you may not be able to operate them. Return the buttons to their normal positions.
- 3** If the pairing screen is displayed, perform pairing again by holding down the  button and  button on the remote control at the same time for about three seconds.



- When pairing, place the remote control within one meter of the projector.
- When pairing starts, the indicator on the remote control flashes. When pairing is complete, the indicator turns off.
- You cannot pair multiple remote controls with the projector at the same time. Pairing a new remote control will unpair the existing one. Make sure the intended remote control is paired.

- 4** Perform pairing again by displaying the pairing screen manually from the **Remotes & Accessories** menu.
- 5** If the image is projected from the projector, make sure you are operating the remote control within the reception angle and range of the projector.

- 6** Strong fluorescent lighting, direct sunlight, or infrared device signals may be interfering with the projector's remote receivers. Dim the lights or move the projector away from the sun or interfering equipment.

- 7** The remote control may be defective. Contact Epson for help.

#### ▶▶ Related Links

- "Remote Control Operation" [p.24](#)
- "Installing Batteries in the Remote Control" [p.24](#)

If you cannot operate the connected devices from the projector, try the following steps until the problem is solved.

- 1** Make sure the cable meets the HDMI CEC standard.
- 2** Make sure the connected device meets the HDMI CEC standard. See the documentation supplied with the device for more information.
- 3** Set **Global CEC control** to **On** in the **Channels & Inputs** menu.  
☛ **Channels & Inputs > Inputs > Global CEC control**
- 4** Make sure all the cables are securely connected to the projector and your video equipment.
- 5** Make sure the connected devices are turned on and in standby status. See the documentation supplied with the device for more information.
- 6** If you connect a new device or change the connection, set the CEC function for the connected device again and restart the device.

## ▶ **Related Links**

- "Operating Connected Devices Using the HDMI CEC Features" [p.51](#)
- "Projector Feature Settings - Channels & Inputs Menu" [p.57](#)

If you cannot connect to a Wi-Fi network, try the following solutions.

- 1** Make sure your Wi-Fi router and modem are working properly. Rebooting these devices may solve the network connection problem.
- 2** Check for obstacles between the Wi-Fi router and the projector, and change their positions to improve communication.
- 3** You can check the network settings from **Wi-Fi** in the **Network & Internet** menu.
- 4** If you initialize the projector, you need to select the network settings again on the initial setup screen.

#### ▶ **Related Links**

- "Initializing the Projector" [p.54](#)

See the following page if you have any problems when watching the online content.

<https://support.google.com/googletv/>

# Appendix

Check these sections for the technical specifications and important notices about your product.

## ► Related Links

- "Optional Accessories and Replacement Parts" [p.88](#)
- "Screen Size and Projection Distance" [p.89](#)
- "Supported Monitor Display Resolutions" [p.90](#)
- "Projector Specifications" [p.91](#)
- "External Dimensions" [p.93](#)
- "List of Safety Symbols and Instructions" [p.94](#)
- "Laser Safety Information" [p.96](#)
- "Glossary" [p.99](#)
- "Notices" [p.100](#)

The following optional accessories and replacement parts are available. Please purchase these products as and when needed.

The following list of optional accessories and replacement parts is current as of: July 2025.

Details of accessories are subject to change without notice and availability may vary depending on the country of purchase.

## ▶ Related Links

- "Screens" [p.88](#)
- "Replacement Parts" [p.88](#)

---

## Screens

### **Ultra Short Throw Screen ELPSC35 (100")**

### **Ultra Short Throw Screen ELPSC36 (120")**

Screens to be installed on a wall. (Aspect ratio 16:9)

---

## Replacement Parts

### **Air filter ELPAF60**

Use as a replacement for used air filters.

## ▶ Related Links

- "Replacing the Air Filter" [p.69](#)

Check the table here to determine how far to place the projector from the screen based on the size of the projected image.

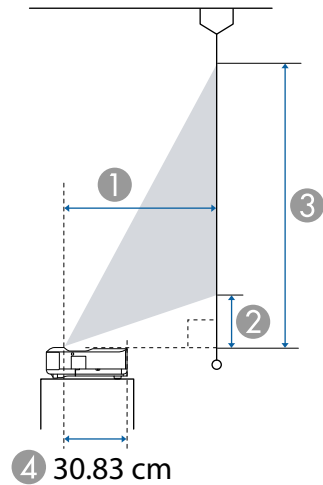

- ① Projection distance (cm)
- ② Distance from the projector to the bottom of the screen (cm)
- ③ Distance from the projector to the top of the screen (cm)
- ④ Distance from the center of the lens to the rear of the projector (cm)

16:9 screen size		①	②	③
60"	133 × 75	32.5	11.5	86.3
65"	144 × 81	35.6	13.0	94.0
70"	155 × 87	38.8	14.5	101.7
75"	166 × 93	42.0	16.0	109.4
80"	177 × 100	45.1	17.5	117.1
90"	199 × 112	51.4	20.5	132.5
100"	221 × 125	57.7	23.5	148.0
120"	266 × 149	70.3	29.4	178.8

4:3 screen size		①	②	③
50"	102 × 76	33.2	11.9	88.1
55"	112 × 84	37.1	13.7	97.5
60"	122 × 91	41.0	15.5	107.0
65"	132 × 99	44.8	17.4	116.4
70"	142 × 107	48.7	19.2	125.9
75"	152 × 114	52.5	21.0	135.3
80"	163 × 122	56.4	22.8	144.7
98"	199 × 149	70.3	29.4	178.7

16:10 screen size		①	②	③
56"	121 × 75	32.8	11.7	87.1
60"	129 × 81	35.6	13.0	93.8
65"	140 × 88	39.0	14.6	102.1
70"	151 × 94	42.4	16.2	110.4
80"	172 × 108	49.2	19.4	127.1
90"	194 × 121	56.0	22.6	143.8
100"	215 × 135	62.8	25.9	160.5
111"	239 × 149	70.3	29.4	178.8

See the *Supplemental A/V Support Specification* for detailed information on compatible refresh rates and resolutions for each compatible video display format.

Product name	EH-LS670B/EH-LS670W
Dimensions	467 (W) × 133 (H) × 400 (D) mm (not including raised section)
LCD panel size	0.62"
Display method	3LCD
Number of pixels	Full HD (1,920 (W) × 1,080 (H) dots) × 3
Screen resolution	4,147,200 pixels*
Focus adjustment	Manual
Light source	Laser diode
Light source output power	Up to 76.5 W
Wavelength	449 to 461 nm
Laser class (internal laser light source)	Class 4
Light source life **	Approx. 20,000 hours
Max. audio output	20 W
Speaker	2.1ch (Speaker × 2, Woofer × 1)
Power supply	100-240V AC±10% 50/60 Hz 2.8 - 1.3 A
Power consumption (100 to 120 V area)	Operating power consumption (When the light source brightness is 100%): 265 W Operating power consumption (When the light source brightness is 50%): 169 W
Power consumption (220 to 240 V area)	Operating power consumption (When the light source brightness is 100%): 254 W Operating power consumption (When the light source brightness is 50%): 162 W
Standby power consumption	Communication On: 2.0 W Communication Off: 0.5 W
Operating altitude	Altitude 0 to 3,048 m

Operating temperature	Altitude of 0 to 2,286 m: +5 to +35°C (Humidity of 20 to 80%, No condensation) Altitude of 2,287 to 3,048 m: +5 to +30°C (Humidity of 20 to 80%, No condensation)
Storage temperature	-10 to 60 °C (Humidity of 10 to 90%, No condensation)
Mass	Approx. 7.4 kg

\* Pixel shifting technology achieves 4K resolution on screen.

\*\* Approximate time until the light source brightness decreases to half of its original value. (Assuming the projector is used in an atmosphere in which airborne particulate matter is less than 0.04 to 0.2mg/m<sup>3</sup>. The estimated time varies depending on the projector usage and operating conditions.)

The rating label is attached on the bottom surface of the projector.

This product is also designed for IT power distribution system with phase-to-phase voltage 230V.

►► **Related Links**

- "Connector Specifications" [p.91](#)
- "Bluetooth Specifications" [p.92](#)

## Connector Specifications

Audio Out port	1	Stereo mini pin jack (3-pin)
HDMI1 port	1	HDMI (Type A)
HDMI2 (eARC/ARC) port	1	HDMI (Type A)
HDMI3 port	1	HDMI (Type A)
USB-A port	2	USB connector (Type A)
Service port	1	USB connector (Mini-B)
Optical Out port	1	Optical digital audio connector (S/PDIF)



USB-A port supports USB 2.0. However, USB ports are not guaranteed to operate all devices that support USB.

## Bluetooth Specifications

Version	Bluetooth Ver. 5.2
Output	Class 2
Communication distance	Approx. 10 m
Supported profiles	A2DP, AVRCP, and HID
Frequency used	2.4 GHz band (2.402 to 2.480 GHz)
Supported codecs	SBC, LC3, APT-X

### **Warning**

Do not use the device near any medical equipment or equipment that is automatically controlled, such as automatic doors or fire alarms. Electromagnetic interference from the device may cause such equipment to malfunction and cause an accident.



- You may not be able to connect depending on the standard and type of device.
- Even when connecting within the specified communication distance, connections can be lost due to the strength of the signal.
- The communication method for Bluetooth uses the same frequency (2.4 GHz) as wireless LAN (IEEE802.11b/g) or microwave ovens. Therefore, if these devices are used at the same time, radio wave interference may occur, the audio may be interrupted, or communication may not be possible. If you do need to use these devices at the same time, make sure there is enough distance between them and the Bluetooth device.

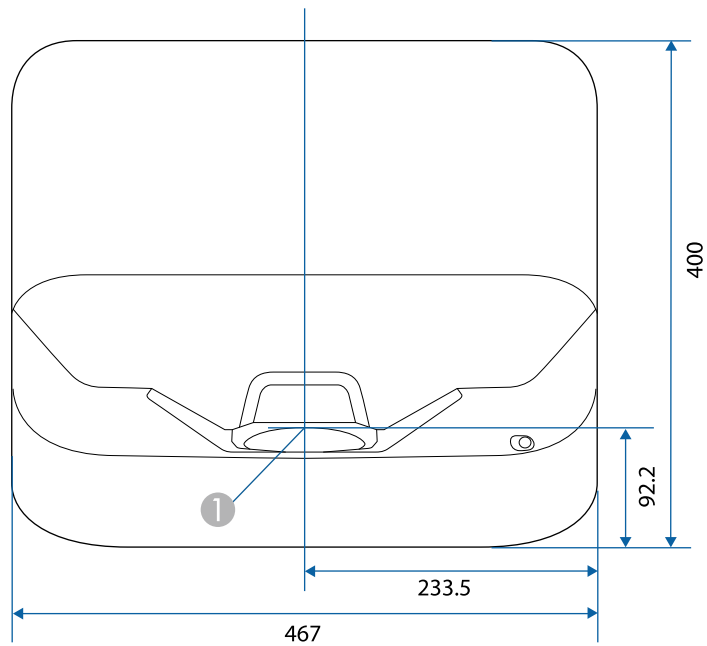



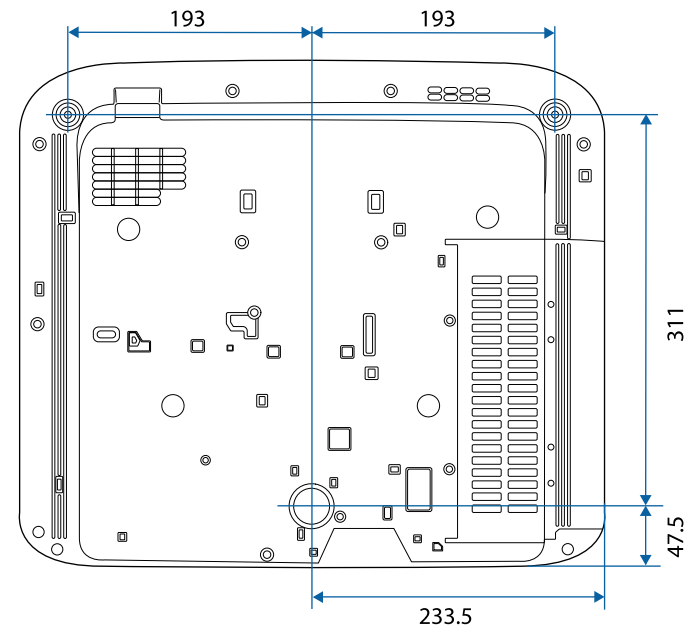

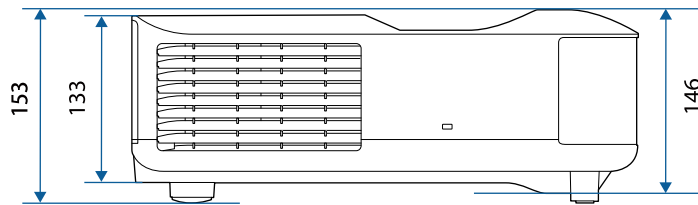

1 Center of the projection window















The unit in these illustrations is mm.

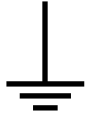



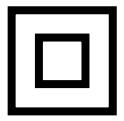

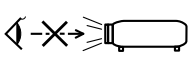



The following table lists the meaning of the safety symbols labeled on the equipment.

No.	Symbol mark	Approved standards	Description
1		IEC60417 No. 5007	"ON" (power) To indicate connection to the mains.
2		IEC60417 No. 5008	"OFF" (power) To indicate disconnection from the mains.
3		IEC60417 No. 5009	Stand-by To identify the switch or switch position by means of which part of the equipment is switched on in order to bring it into the stand-by condition.
4		ISO7000 No. 0434B, IEC3864-B3.1	Caution To identify general caution when using the product.
5		IEC60417 No. 5041	Caution, hot surface To indicate that the marked item can be hot and should not be touched without taking care.
6		IEC60417 No. 6042 ISO3864-B3.6	Caution, risk of electric shock To identify equipment that has risk of electric shock.
7		IEC60417 No. 5957	For indoor use only To identify electrical equipment designed primarily for indoor use.

No.	Symbol mark	Approved standards	Description
8		IEC60417 No. 5926	Polarity of d.c. power connector To identify the positive and negative connections (the polarity) on a piece of equipment to which a d.c. power supply may be connected.
9		—	The same as No. 8.
10		IEC60417 No. 5001B	Battery, general On battery powered equipment. To identify a device for instance a cover for the battery compartment, or the connector terminals.
11		IEC60417 No. 5002	Positioning of cell To identify the battery holder itself and to identify the positioning of the cell(s) inside the battery holder.
12		—	The same as No. 11.
13		IEC60417 No. 5019	Protective earth To identify any terminal which is intended for connection to an external conductor for protection against electric shock in case of a fault, or the terminal of a protective earth electrode.
14		IEC60417 No. 5017	Earth To identify an earth (ground) terminal in cases where neither the symbol No. 13 is explicitly required.

No.	Symbol mark	Approved standards	Description
15		IEC60417 No. 5032	Alternating current To indicate on the rating plate that the equipment is suitable for alternating current only; to identify relevant terminals.
16		IEC60417 No. 5031	Direct current To indicate on the rating plate that the equipment is suitable for direct current only; to identify relevant terminals.
17		IEC60417 No. 5172	Class II equipment To identify equipment meeting the safety requirements specified for Class II equipment according to IEC 61140.
18		ISO 3864	General prohibition To identify actions or operations that are prohibited.
19		ISO 3864	Contact prohibition To indicate injury that could occur due to touching a specific part of the equipment.
20		—	Never look into the optical lens while the projector is on.
21		—	To indicate that the marked item don't place anything on projector.
22		ISO3864 IEC60825-1	Caution, laser radiation To indicate the equipment has a laser radiation part.

No.	Symbol mark	Approved standards	Description
23		ISO 3864	Disassembly prohibition To indicate a risk of injury, such as electric shock, if the equipment is disassembled.
24		IEC60417 No. 5266	Standby, partial standby To indicate that part of the equipment is in the ready status.
25		ISO3864 IEC60417 No. 5057	Caution, movable parts To indicate that you must keep away from movable parts according to protection standards.
26		IEC60417 No. 6056	Caution (Moving Fan Blades) As a safety precaution, stay away from the moving fan blades.
27		IEC60417 No. 6043	Caution (Sharp Corners) To indicate sharp corners that should not be touched.
28		—	To indicate that looking into the lens while projecting is prohibited.
29		ISO7010 No. W027 ISO 3864	Warning, Optical radiation (such as UV, visible radiation, IR) Taking care to avoid injury to eyes and skin when in the vicinity of optical radiation.
30		IEC60417 No. 5109	Not to be used in residential areas. To identify electrical equipment which is not suitable for a residential area.

This product is a laser projector that projects images onto surfaces such as walls and screens.

This projector is a Class 1 consumer laser product that complies with the following standards:

- IEC60825-1:2014
- EN60825-1:2014+A11:2021
- EN50689:2021

Follow these safety instructions when using the projector.

## Warning

- Do not open the projector's case. The projector contains a high-powered laser.
- Possibly hazardous optical radiation emitted from this product. Do not look at operating light source. Eye injury may result.

## Caution

Do not disassemble the projector when disposing of it. Dispose according to your local or national laws and regulations.



The projector uses a laser as the light source. The laser has the following characteristics.

- Depending on the surroundings, the brightness of the light source may decline. The brightness declines a lot when the temperature gets too high.
- The brightness of the light source declines the longer it is used. You can change the relationship between usage time and decline in brightness settings.

## ▶ Related Links

- "Laser Warning Labels" [p.96](#)

## Laser Warning Labels

Laser warning labels are attached on the projector.

### Inside



### Top

As with any bright source, do not stare into the beam, RG2 IEC/EN 62471-5:2015.

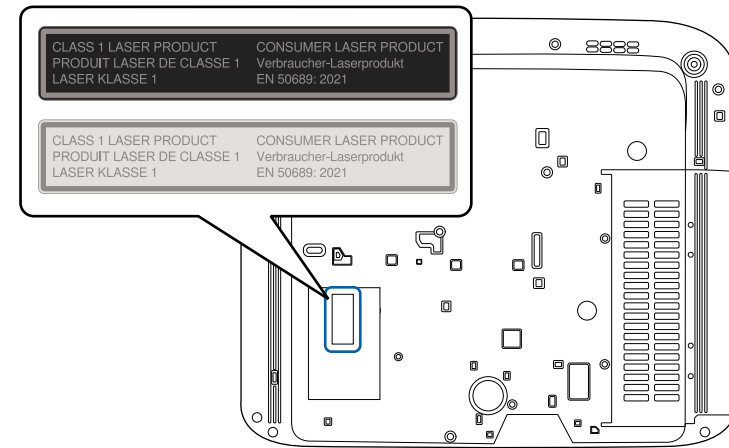
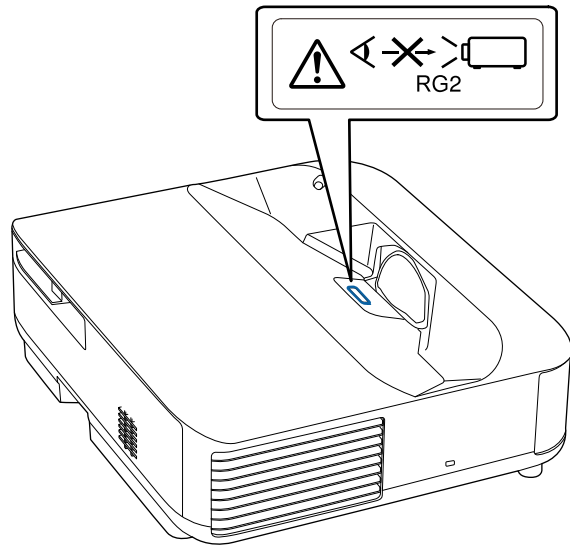

## **Warning**

- Never look into the projector lens when the laser is on. This can damage your eyes and is especially dangerous for children and pets.
- When turning on the projector at a distance using the remote control, make sure no one is looking into the lens.
- Do not allow small children to operate the projector. Children must be accompanied by an adult.
- Do not look into the lens during projection. Also, do not look into the lens using optical devices, such as a magnifying glass or telescope. This could cause visual impairment.

## **Base**

This projector is a consumer CLASS 1 laser product that complies with the EN50689:2021.

This projector is the product that projects images onto walls, screens, etc.

## **Base**

### **For North/South America**

Complies with 21 CFR 1040.10 and 1040.11 except for conformance as a Risk Group 2 LIP as defined in IEC 62471-5: Ed. 1.0. For more information see Laser Notice No. 57, dated May 8, 2019.

### **Rating Labels (EH-LS670W/EH-LS670B)**

The rating label contains the certification and identification information for the projector.

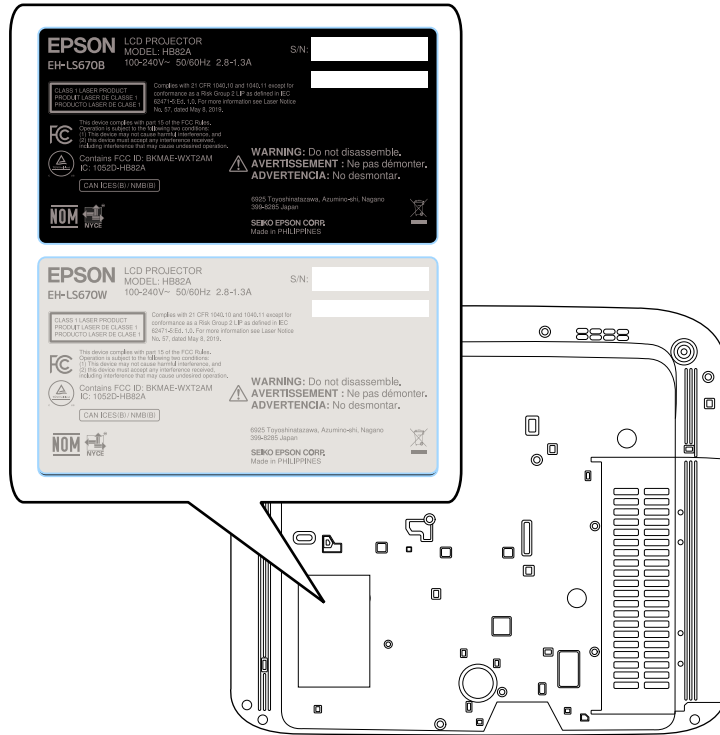

This section briefly explains the difficult terms that are not explained in the text of this guide. For details, refer to other commercially available publications.

Aspect Ratio	The ratio between an image's length and its height. Screens with a horizontal:vertical ratio of 16:9, such as HDTV screens, are known as wide screens. SDTV and general computer displays have an aspect ratio of 4:3.
Contrast	The relative brightness of the light and dark areas of an image can be increased or decreased to make text and graphics stand out more clearly, or to make them appear softer. Adjusting this particular property of an image is called contrast adjustment.
4K	A screen size standard with a resolution of 3,840 (horizontal) × 2,160 (vertical) dots.
Full HD	A screen size standard with a resolution of 1,920 (horizontal) × 1,080 (vertical) dots.
HDCP	HDCP is an abbreviation for High-bandwidth Digital Content Protection. It is used to prevent illegal copying and protect copyrights by encrypting digital signals sent over DVI and HDMI ports. Because the HDMI port on this projector supports HDCP, it can project digital images protected by HDCP technology. However, the projector may not be able to project images protected with updated or revised versions of HDCP encryption.
HDMI™	An abbreviation for High Definition Multimedia Interface. HDMI™ is a standard aimed at digital consumer electronics and computers. This is the standard by which HD images and multichannel audio signals are digitally transmitted. By not compressing the digital signal, the image can be transferred at the highest quality possible. It also provides an encryption function for the digital signal.

HDTV	An abbreviation for High-Definition Television that refers to high-definition systems which satisfy the following conditions: <ul style="list-style-type: none"> <li>• Vertical resolution of 720p or 1080i or greater (p = Progressive, i = Interlace)</li> <li>• Screen aspect ratio of 16:9</li> </ul>
Pairing	Register devices in advance when connecting with Bluetooth devices to ensure mutual communication.
Refresh Rate	The light-emitting element of a display maintains the same luminosity and color for an extremely short time. Because of this, the image must be scanned many times per second to refresh the light-emitting element. The number of refresh operations per second is called the Refresh rate and is expressed in hertz (Hz).
SDTV	An abbreviation for Standard Definition Television that refers to standard television systems which do not satisfy the conditions for HDTV High-Definition Television.

Check these sections for important notices about your projector.

► **Related Links**

- "FCC Compliance Statement" [p.100](#)
- "Indication of the manufacturer and the importer in accordance with requirements of EU directive" [p.101](#)
- "Restriction of Use" [p.101](#)
- "Trademarks" [p.101](#)
- "Copyright Notice" [p.101](#)
- "Copyright Attribution" [p.102](#)

---

## FCC Compliance Statement

**Supplier's DECLARATION of CONFORMITY**

According to 47CFR, Part 2 and 15

Class B Personal Computers and Peripherals; and/or

CPU Boards and Power Supplies used with Class B Personal Computers

We: Epson America, Inc.

Located at: 3131 Katella Avenue, Los Alamitos, CA

Tel: 562-981-3840

Declare under sole responsibility that the product identified herein, complies with 47CFR Part 2 and 15 of the FCC rules as a Class B digital device. Each product marketed, is identical to the representative unit tested and found to be compliant with the standards. Records maintained continue to reflect the equipment being produced can be expected to be within the variation accepted, due to quantity production and testing on a statistical basis as required by 47CFR 2.906. Operation is subject to the following two conditions: (1) this device may not cause harmful interference, and (2) this device must accept any interference received, including interference that may cause undesired operation.

Trade Name: EPSON

Type of Product: LCD Projector

Model: HB82B/HB82J

### FCC Compliance Statement For United States Users

This device complies with part 15 of the FCC Rules. Operation is subject to the following two conditions: (1) This device may not cause harmful interference, and (2) this device must accept any interference received, including interference that may cause undesired operation.

This equipment has been tested and found to comply with the limits for a Class B digital device, pursuant to Part 15 of the FCC Rules. These limits are designed to provide reasonable protection against harmful interference in a residential installation. This equipment generates, uses, and can radiate radio frequency energy and, if not installed and used in accordance with the instructions, may cause harmful interference to radio communications. However, there is no guarantee that interference will not occur in a particular installation. If this equipment does cause interference to radio and television reception, which can be determined by turning the equipment off and on, the user is encouraged to try to correct the interference by one or more of the following measures.

- Reorient or relocate the receiving antenna.
- Increase the separation between the equipment and receiver.
- Connect the equipment into an outlet on a circuit different from that to which the receiver is connected.
- Consult the dealer or an experienced radio/TV technician for help.

### WARNING

The connection of a non-shielded equipment interface cable to this equipment will invalidate the FCC Certification or Declaration of this device and may cause interference levels which exceed the limits established by the FCC for this equipment. It is the responsibility of the user to obtain and use a shielded equipment interface cable with this device. If this equipment has more than one interface connector, do not leave cables connected to unused interfaces. Changes or modifications not expressly approved by the manufacturer could void the user's authority to operate the equipment.

For Canadian Users

CAN ICES(B) / NMB(B)

## Indication of the manufacturer and the importer in accordance with requirements of EU directive

Manufacturer: SEIKO EPSON CORPORATION  
Address: 3-5, Owa 3-chome, Suwa-shi, Nagano-ken 392-8502 Japan  
Telephone: 81-266-52-3131  
<http://www.epson.com/>

Importer: EPSON EUROPE B.V.  
Address: Atlas Arena, Asia Building, Hoogoorddreef 5,1101 BA Amsterdam Zuidoost  
The Netherlands  
Telephone: 31-20-314-5000  
<http://www.epson.eu/>

## Restriction of Use

When this product is used for applications requiring high reliability/safety such as transportation devices related to aviation, rail, marine, automotive etc.; disaster prevention devices; various safety devices etc; or functional/precision devices etc, you should use this product only after giving consideration to including fail-safes and redundancies into your design to maintain safety and total system reliability. Because this product was not intended for use in applications requiring extremely high reliability/safety such as aerospace equipment, main communication equipment, nuclear power control equipment, or medical equipment related to direct medical care etc, please make your own judgment on this product's suitability after a full evaluation.

## Trademarks

Mac, OS X, and macOS are trademarks of Apple Inc.

Microsoft, Windows, and the Windows logo are trademarks or registered trademarks of Microsoft Corporation in the United States and/or other countries.

Google TV is the name of this device's software experience and a trademark of Google LLC. Google, YouTube and Google Cast are trademarks of Google LLC.

Manufactured under license from Dolby Laboratories. Dolby, Dolby Audio, and the double-D symbol are trademarks of Dolby Laboratories Licensing Corporation.

The terms HDMI, HDMI High-Definition Multimedia Interface, HDMI Trade dress and the HDMI Logos are trademarks or registered trademarks of HDMI Licensing Administrator, Inc. 

"QR Code" is a registered trademark of DENSO WAVE INCORPORATED.

Wi-Fi<sup>®</sup> is a trademark of the Wi-Fi Alliance<sup>®</sup>.

The Bluetooth<sup>®</sup> word mark and logos are registered trademarks owned by Bluetooth SIG, Inc. and any use of such marks by Seiko Epson Corporation is under license. Other trademarks and trade names are those of their respective owners.

Adobe and Adobe Reader are either registered trademarks or trademarks of Adobe Systems Incorporated in the United States and/or other countries.

Other product names used herein are also for identification purposes only and may be trademarks of their respective owners. Epson disclaims any and all rights in those marks.

## Copyright Notice

All rights reserved. No part of this publication may be reproduced, stored in a retrieval system, or transmitted in any form or by any means, electronic, mechanical, photocopying, recording, or otherwise, without the prior written permission of Seiko Epson Corporation. No patent liability is assumed with

respect to the use of the information contained herein. Neither is any liability assumed for damages resulting from the use of the information contained herein.

Neither Seiko Epson Corporation nor its affiliates shall be liable to the purchaser of this product or third parties for damages, losses, costs, or expenses incurred by the purchaser or third parties as a result of: accident, misuse, or abuse of this product or unauthorized modifications, repairs, or alterations to this product, or (excluding the U.S.) failure to strictly comply with Seiko Epson Corporation's operating and maintenance instructions.

Seiko Epson Corporation shall not be liable against any damages or problems arising from the use of any options or any consumable products other than those designated as Original Epson Products or Epson Approved Products by Seiko Epson Corporation.

The contents of this guide may be changed or updated without further notice.

---

## Copyright Attribution

This information is subject to change without notice.

© 2025 Seiko Epson Corporation

2025.09 414641501EN